



Castel[®]

MAMPARAS DE BAÑO

En **Castel** nos esforzamos por brindar nuevas soluciones en el conjunto de su baño. Es por ésto que nos complace poder ofrecerle nuestra apuesta por diversas mamparas de baño con las que, estamos seguros, creará su espacio perfecto. Mamparas de calidad, con infinidad de diseños y acabados con los que poder dar rienda suelta a su imaginación y modelar ese espacio tan personal como es su baño de ensueño. Con las últimas tendencias en diseño, sin dejar de lado lo clásico, el ímpetu con el que abordamos esta etapa, junto con nuestra experiencia, creatividad y calidad en el mundo del baño, seguro satisface todas sus necesidades.

Castel, más que un estilo.

At Castel we strive to provide new solutions in your bathroom as a whole. This is why we are pleased to be able to offer you our commitment to various bathroom screens, with which we are sure, will create your perfect space. Quality partitions, with an infinite number of designs and finishes with which to be able to give free rein to your imagination and model that space as personal as your dream bathroom. With the latest trends in design, without neglecting the classic, the impetus with which we approached this stage, together with our experience, creativity and quality in the bathroom world, sure to satisfy all your needs.

Castel, more than a style.

Chez Castel, nous nous efforçons d'apporter de nouvelles solutions dans votre salle de bain dans son ensemble. C'est pourquoi nous sommes heureux de pouvoir vous proposer notre engagement dans différents écrans de salle de bain, avec lesquels nous sommes sûrs, créeront votre espace parfait. Des cloisons de qualité, avec un nombre infini de designs et de finitions avec lesquels pour pouvoir laisser libre cours à votre imagination et modéliser cet espace aussi personnel que la salle de bain de vos rêves. Avec les dernières tendances en matière de design, sans négliger le classique, l'élan avec lequel nous avons abordé cette étape, ainsi que notre expérience, créativité et qualité dans le monde de la salle de bains, pour satisfaire tous vos besoins.

Castel, plus qu'un style.



ÍNDICE / CONTENTS / SOMMAIRE

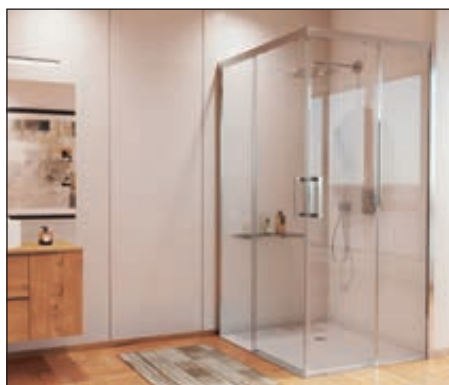

MAGNA Pág. 4 - 11



ATEMPO Pág. 12 - 19

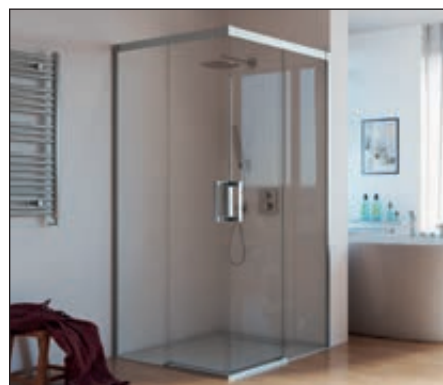

LUXURY Pág. 20 - 27



ELEGANT Pág. 28 - 35



FREE Pág. 36 - 43



URBAN Pág. 44 - 51

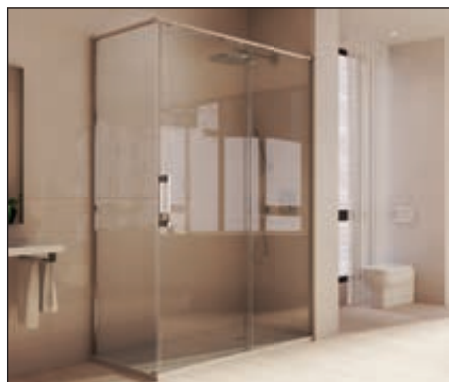

SLIM Pág. 52 - 57



COSMOS Pág. 58 - 69



ECO Pág. 70 - 77



TOP Pág. 78 - 83



TREBOL Pág. 84 - 89

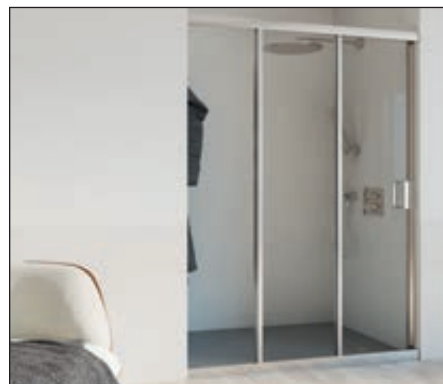

TRENTO Pág. 90 - 93



DOUBLE Pág. 94 - 97



TEDY Pág. 98 - 109



PADEL Pág. 110 - 121



ACORD Pág. 122 - 129



DUPLEX Pág. 130 - 135



MIXTA Pág. 136 - 139



WALL Pág. 140 - 157



BAÑERAS Pág. 158 - 163



DUCHAS Pág. 164 - 171

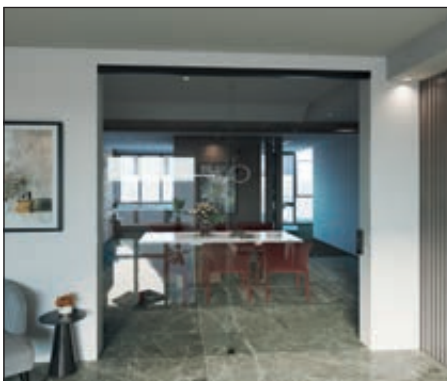

RIVER Pág. 172 - 173



HIDE Pág. 174 - 175



OCEAN Pág. 176 - 177

MAGNA

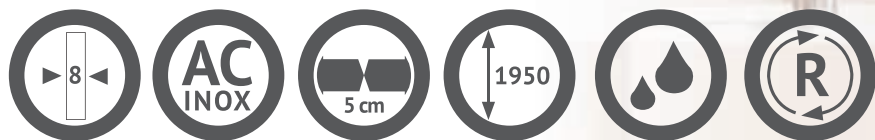





Modelo **MAGNA 100**. Mampara Frontal Corredera



Modelo **MAGNA 400**. Mampara Angular Corredera. Entrada frontal.



Modelo **MAGNA 200**. Mampara Frontal Corredera.

MAMPARA DE BAÑO SERIE MAGNA 100

BATHROOM SCREEN MAGNA 100 SERIES | ÉCRAN DE SALLE DE BAIN SÉRIE MAGNA 100

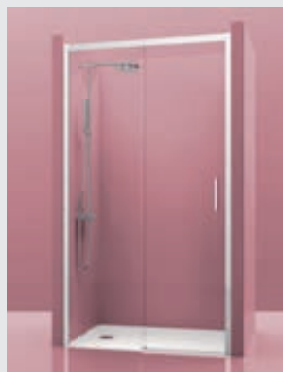

MAMPARA ESTANDAR

CÓDIGO	MEDIDA	RANGO DE INSTALACIÓN	TRANSPARENTE	DECORADO		APERTURA
				GRUPO I	GRUPO II	
MG1100	100	97,5-102,5	670 €	746 €	791 €	37
MG1105	105	102,6-107,5	676 €	752 €	797 €	39
MG1110	110	107,6-112,5	681 €	758 €	803 €	42
MG1115	115	112,6-117,5	687 €	763 €	808 €	44
MG1120	120	117,6-122,5	693 €	769 €	814 €	47
MG1125	125	122,6-127,5	699 €	775 €	820 €	49
MG1130	130	127,6-132,5	705 €	781 €	826 €	52
MG1135	135	132,6-137,5	714 €	790 €	835 €	54
MG1140	140	137,6-142,5	723 €	799 €	844 €	57
MG1145	145	142,6-147,5	732 €	843 €	933 €	59
MG1150	150	147,6-152,5	742 €	856 €	946 €	62
MG1155	155	152,6-157,5	751 €	869 €	959 €	64
MG1160	160	157,6-162,5	760 €	882 €	972 €	67
MG1165	165	162,6-167,5	769 €	895 €	985 €	69
MG1170	170	167,6-172,5	778 €	908 €	998 €	72
MG1175	175	172,6-177,5	788 €	921 €	1.011 €	74
MG1180	180	177,6-182,5	797 €	934 €	1.024 €	77

ESPECIALES A MEDIDA

CÓDIGO	MEDIDA	TRANSPARENTE	DECORADO	
			GRUPO I	GRUPO II
MGS1120	HASTA120	918 €	1.019 €	1.064 €
MGS1140	HASTA140	958 €	1.059 €	1.104 €
MGS1160	HASTA160	1.007 €	1.168 €	1.258 €
MGS1180	HASTA180	1.056 €	1.238 €	1.328 €
MGS1200	HASTA200	1.105 €	1.306 €	1.396 €
MGS1220	HASTA220	1.154 €	1.365 €	1.455 €

MAMPARA DE BAÑO SERIE MAGNA 200

BATHROOM SCREEN MAGNA 200 SERIES | ÉCRAN DE SALLE DE BAIN SÉRIE MAGNA 200



MAMPARA ESTANDAR

CÓDIGO	MEDIDA	RANGO DE INSTALACIÓN	TRANSPARENTE	DECORADO		APERTURA
				GRUPO I	GRUPO II	
MG2160	160	157,6-162,5	855 €	1.007 €	1.097 €	61
MG2170	170	167,6-172,5	878 €	1.030 €	1.120 €	68
MG2180	180	177,6-182,5	901 €	1.053 €	1.143 €	73

ESPECIALES A MEDIDA

CÓDIGO	MEDIDA	TRANSPARENTE	DECORADO	
			GRUPO I	GRUPO II
MGS2140	HASTA140	1.132 €	1.334 €	1.379 €
MGS2160	HASTA160	1.163 €	1.365 €	1.455 €
MGS2180	HASTA180	1.193 €	1.395 €	1.485 €
MGS2200	HASTA200	1.224 €	1.426 €	1.516 €
MGS2220	HASTA220	1.255 €	1.457 €	1.547 €

MAMPARA DE BAÑO SERIE MAGNA 300

BATHROOM SCREEN MAGNA 300 SERIES | ÉCRAN DE SALLE DE BAIN SÉRIE MAGNA 300



MAMPARA ESTANDAR

CÓDIGO	MEDIDA	RANGO DE INSTALACIÓN	TRANSPARENTE	DECORADO		APERTURA
				GRUPO I	GRUPO II	
MG3077	70 x 70	67,5-70/67,5-70	866 €	1.019 €	1.109 €	32 – 34
MG3088	80 x 80	77,5-80/77,5-80	884 €	1.053 €	1.143 €	44 – 45
MG3099	90 x 90	87,5-90/87,5-90	901 €	1.076 €	1.166 €	44 – 45
MG3087	80 x 70	77,5-80/67,5-70	875 €	1.035 €	1.125 €	35 – 44
MG3097	90 x 70	87,5-90/67,5-70	884 €	1.048 €	1.138 €	35 – 44
MG3098	90 x 80	87,5-90/77,5-80	893 €	1.068 €	1.158 €	44 – 45
MG3101	100 x 100	97,5-100/97,5-100	1.034 €	1.183 €	1.273 €	44 – 46
MG3107	100 x 70	97,5-100/67,5-70	969 €	1.106 €	1.196 €	43 – 45
MG3108	100 x 80	97,5-100/77,5-80	981 €	1.132 €	1.222 €	45 – 47
MG3109	100 x 90	97,5-100/87,5-90	992 €	1.143 €	1.233 €	45 – 47
MG3117	110 x 70	107,6-110 / 67,5-70	1.132 €	1.282 €	1.372 €	48 – 53
MG3118	110 x 80	107,6-110 / 77,5-80	1.141 €	1.294 €	1.384 €	50 – 55
MG3119	110 x 90	107,6-110 / 87,5-90	1.149 €	1.302 €	1.392 €	50 – 55
MG3127	120 x 70	117,6-120/67,5-70	1.143 €	1.283 €	1.373 €	50 – 55
MG3128	120 Xx 80	117,6-120/77,5-80	1.153 €	1.305 €	1.395 €	52 – 57
MG3129	120 x 90	117,6-120/87,5-90	1.161 €	1.313 €	1.403 €	52 – 57
MG3137	130 x 70	127,6-130/67,5-70	1.155 €	1.295 €	1.385 €	50 – 55
MG3138	130 x 80	127,6-130/77,5-80	1.164 €	1.317 €	1.407 €	52 – 57
MG3139	130 X 90	127,6-130/88,5-90	1.172 €	1.325 €	1.445 €	52 – 57
MG3147	140 x 70	137,6-140/67,5-70	1.173 €	1.313 €	1.433 €	60 – 65
MG3148	140 x 80	137,6-140/77,5-80	1.183 €	1.335 €	1.455 €	62 – 67
MG3149	140 x 90	137,6-140/87,5-90	1.191 €	1.343 €	1.463 €	62 – 67

ESPECIALES A MEDIDA SÓLO LATERAL

CÓDIGO	MEDIDA	TRANSPARENTE	DECORADO	
			GRUPO I	GRUPO II
MGS3070	HASTA70	597 €	698 €	743 €
MGS3090	HASTA90	620 €	721 €	766 €
MGS3110	HASTA110	631 €	732 €	777 €

SÓLO LATERAL

CÓDIGO	MEDIDA	RANGO DE INSTALACIÓN	TRANSPARENTE	DECORADO	
				GRUPO I	GRUPO II
MG307	70	67,5-70	450 €	497 €	542 €
MG308	80	77,5-80	460 €	537 €	582 €
MG309	90	87,5-90	468 €	565 €	610 €

MAMPARA DE BAÑO SERIE MAGNA 400

BATHROOM SCREEN MAGNA 400 SERIES | ÉCRAN DE SALLE DE BAIN SÉRIE MAGNA 400



MAMPARA ESTANDAR

CÓDIGO	MEDIDA	RANGO DE INSTALACIÓN	TRANSPARENTE	DECORADO		APERTURA
				GRUPO I	GRUPO II	
MG4127	120 x 70	117,5-120/ 68-69,5	1.052 €	1.190 €	1.280 €	47
MG4128	120 x 80	117,5-120/ 78-79,5	1.065 €	1.213 €	1.303 €	47
MG4137	130 x 70	127,5-130/68-69,5	1.085 €	1.223 €	1.313 €	52
MG4138	130 x 80	127,5-130/ 78-79,5	1.098 €	1.246 €	1.336 €	52
MG4147	140 x 70	137,5-140/68-69,5	1.110 €	1.249 €	1.339 €	57
MG4148	140 x 80	137,5-140/78-79,5	1.124 €	1.272 €	1.362 €	57
MG4157	150 x 70	147,5-150/68-69,5	1.128 €	1.304 €	1.424 €	62
MG4158	150 x 80	147,5-150/78-79,5	1.141 €	1.327 €	1.447 €	62
MG4167	160 x 70	157,5-160/68-69,5	1.148 €	1.333 €	1.453 €	67
MG4168	160 x 80	157,5-160/78-79,5	1.162 €	1.355 €	1.475 €	67
MG4177	170 x 70	167,5-170/68-69,5	1.163 €	1.360 €	1.480 €	72
MG4178	170 x 80	167,5-170/78-79,5	1.181 €	1.383 €	1.503 €	72
MG4187	180 x 70	177,5-180/68-79,5	1.186 €	1.412 €	1.532 €	77
MG4188	180 x 80	177,5-180/78-79,5	1.199 €	1.434 €	1.554 €	77

ESPECIALES A MEDIDA SÓLO LATERAL

CÓDIGO	MEDIDA	TRANSPARENTE	DECORADO	
			GRUPO I	GRUPO II
MGS4070	HASTA70	433 €	520 €	565 €
MGS4090	HASTA90	497 €	607 €	652 €
MGS4110	HASTA110	559 €	696 €	741 €

SÓLO LATERAL

CÓDIGO	MEDIDA	RANGO DE INSTALACIÓN	TRANSPARENTE	DECORADO	
				GRUPO I	GRUPO II
MG407	70	68 - 69,5	381 €	443 €	563 €
MG408	80	78 - 79,5	394 €	466 €	586 €
MG409	90	88 - 89,5	407 €	480 €	600 €

MAMPARA DE BAÑO SERIE MAGNA 900BATHROOM SCREEN MAGNA 900 SERIES | ÉCRAN DE SALLE DE BAIN SÉRIE MAGNA 900
PLAZO DE ENTREGA 15 DÍAS

MAMPARA ESTANDAR

CÓDIGO	MEDIDA	TRANSPARENTE	DECORADO	
			GRUPO I	GRUPO II
MG9140	HASTA140	871 €	1.050 €	1.095 €
MG9160	HASTA160	895 €	1.080 €	1.170 €
MG9180	HASTA180	918 €	1.097 €	1.187 €
MA9200	HASTA200	953 €	1.159 €	1.249 €

ESPECIALES A MEDIDA

CÓDIGO	MEDIDA	TRANSPARENTE	DECORADO	
			GRUPO I	GRUPO II
MGS9140	HASTA140	1.132 €	1.259 €	1.304 €
MGS9160	HASTA160	1.163 €	1.297 €	1.387 €
MGS9180	HASTA180	1.193 €	1.316 €	1.406 €
MGS9200	HASTA200	1.224 €	1.391 €	1.481 €

DIMENSIONES MÁXIMAS MAMPARAS A MEDIDA

- Altura máxima 1950 mm
- Ancho máximo 2200 mm

ESPECIFICACIONES TRAMITACIÓN PEDIDOS

- Indicar medida de hueco real para adaptar la mejor opción y evitar errores de códigos
- Indicar posición de puerta mirando la mampara desde fuera (mano)
- Especificar cuando el plato este enrasado a suelo o sea de obra.

PLAZO DE EXPEDICIONES

- Transparentes 48 horas
- Decorados 5 días hábiles GRUPO 1 (EXCEPTO MATE Y PARSOLES)
- Cristales especiales y decorados (GRUPO 2, MATE Y PARSOLES) 15 días

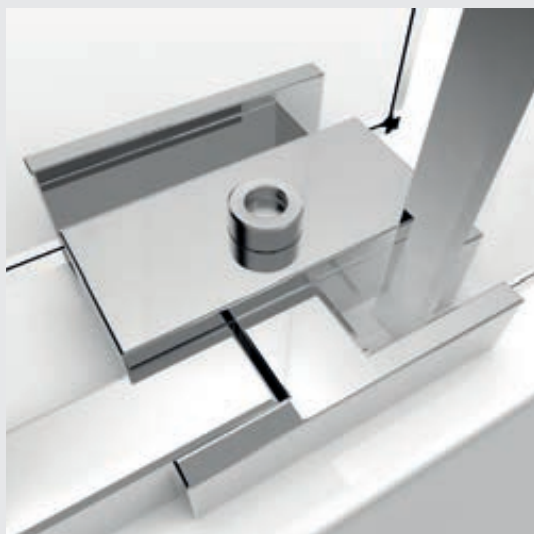



ATEMPO

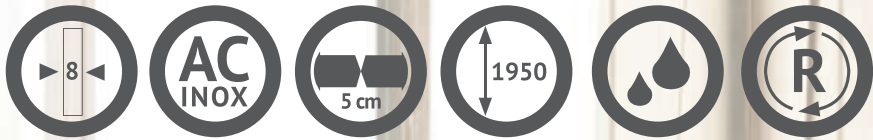



Modelo **ATEMPO 100**. Mampara Frontal Corredera



Modelo **ATEMPO 200**. Mampara Frontal Corredera.

MAMPARA DE BAÑO SERIE ATEMPO 100

BATHROOM SCREEN ATEMPO 100 SERIES | ÉCRAN DE SALLE DE BAIN SÉRIE ATEMPO 100



MAMPARA ESTANDAR

CÓDIGO	MEDIDA	RANGO DE INSTALACIÓN	TRANSPARENTE	DECORADO		APERTURA
				GRUPO I	GRUPO II	
AT1100	100	97 - 102	564 €	651 €	696 €	40 - 45
AT1105	105	103 - 107	588 €	676 €	721 €	40 - 45
AT1110	110	108 - 112	625 €	713 €	758 €	45 - 50
AT1115	115	113 - 117	641 €	730 €	775 €	42 - 47
AT1120	120	118 - 122	658 €	747 €	792 €	47 - 52
AT1125	125	123 - 127	674 €	763 €	808 €	52 - 57
AT1130	130	128 - 132	691 €	780 €	825 €	47 - 52
AT1135	135	133 - 137	703 €	792 €	837 €	52 - 57
AT1140	140	138 - 142	716 €	806 €	851 €	57 - 62
AT1145	145	143 - 147	724 €	849 €	939 €	52 - 57
AT1150	150	148 - 152	733 €	861 €	951 €	57 - 62
AT1155	155	153 - 157	742 €	875 €	965 €	57 - 62
AT1160	160	158 - 162	753 €	890 €	980 €	62 - 67
AT1165	165	163 - 167	763 €	903 €	993 €	62 - 67
AT1170	170	168 - 172	772 €	917 €	1.007 €	62 - 67
AT1175	175	173 - 177	794 €	943 €	1.033 €	62 - 67
AT1180	180	178 - 182	815 €	969 €	1.059 €	62 - 67

ESPECIALES A MEDIDA

CÓDIGO	MEDIDA	TRANSPARENTE	DECORADO	
			GRUPO I	GRUPO II
ATS1120	HASTA 120	819 €	929 €	974 €
ATS1140	HASTA 140	879 €	955 €	1.000 €
ATS1160	HASTA 160	940 €	1.025 €	1.115 €
ATS1180	HASTA 180	1.000 €	1.095 €	1.185 €
ATS1200	HASTA 200	1.061 €	1.165 €	1.255 €
ATS1220	HASTA 220	1.121 €	1.235 €	1.325 €

MAMPARA DE BAÑO SERIE ATEMPO 200

BATHROOM SCREEN ATEMPO 200 SERIES | ÉCRAN DE SALLE DE BAIN SÉRIE ATEMPO 200



MAMPARA ESTANDAR

CÓDIGO	MEDIDA	RANGO DE INSTALACIÓN	TRANSPARENTE	DECORADO		APERTURA
				GRUPO I	GRUPO II	
AT2160	160	152 - 162	861 €	1.030 €	1.120 €	52 - 61
AT2170	170	162 - 172	889 €	1.058 €	1.148 €	62 - 71
AT2180	180	173 - 182	915 €	1.085 €	1.175 €	62 - 71

ESPECIALES A MEDIDA

CÓDIGO	MEDIDA	TRANSPARENTE	DECORADO	
			GRUPO I	GRUPO II
ATS2140	HASTA 140	983 €	1.161 €	1.206 €
ATS2160	HASTA 160	1.044 €	1.216 €	1.306 €
ATS2180	HASTA 180	1.104 €	1.281 €	1.371 €
ATS2200	HASTA 200	1.165 €	1.360 €	1.450 €
ATS2220	HASTA 220	1.226 €	1.441 €	1.531 €

MAMPARA DE BAÑO SERIE ATEMPO 300

BATHROOM SCREEN ATEMPO 300 SERIES | ÉCRAN DE SALLE DE BAIN SÉRIE ATEMPO 300



MAMPARA ESTANDAR

CÓDIGO	MEDIDA	RANGO DE INSTALACIÓN	TRANSPARENTE	DECORADO		APERTURA
				GRUPO I	GRUPO II	
AT3077	70X70	66-70 / 66-70	826 €	995 €	1.085 €	32 - 34
AT3088	80 x 80	76-80 / 76-80	904 €	1.074 €	1.164 €	44 -- 45
AT3099	90 x 90	86-90 / 86-90	960 €	1.131 €	1.221 €	44 - 45
AT3087	80X70	76-80 / 66-70	865 €	1.035 €	1.125 €	35 - 44
AT3097	90X70	86-90 / 66-70	893 €	1.063 €	1.153 €	35 - 44
AT3098	90X80	86-90 / 76-80	932 €	1.103 €	1.193 €	44 - 45
AT3101	100 X 100	96-100 / 96-100	1.080 €	1.253 €	1.343 €	44 - 46
AT3107	100 x 70	96-100 / 66-70	948 €	1.118 €	1.208 €	43 - 45
AT3108	100 x 80	96-100 / 76-80	996 €	1.167 €	1.257 €	45 - 47
AT3109	100 X 90	96-100 / 86-90	1.056 €	1.229 €	1.319 €	45 - 47
AT3117	110 X 70	102-110 / 66-70	1.038 €	1.242 €	1.332 €	48 - 53
AT3118	110 x 80	102-110 / 76-80	1.080 €	1.253 €	1.373 €	50 - 55
AT3119	110 X 90	102-110 / 86-90	1.092 €	1.265 €	1.385 €	50 - 55
AT3127	120 x 70	112-120 / 66-70	1.071 €	1.232 €	1.352 €	50 - 55
AT3128	120 X 80	112-120 / 76-80	1.104 €	1.278 €	1.398 €	52 - 57
AT3129	120 X 90	112-120 / 86-90	1.128 €	1.302 €	1.422 €	52 - 57
AT3137	130 x 70	122-130 / 66-70	1.104 €	1.265 €	1.385 €	50 - 55
AT3138	130 X 80	122-130 / 76-80	1.140 €	1.314 €	1.434 €	52 - 57
AT3139	130 X 90	122-130 / 86-90	1.152 €	1.327 €	1.447 €	52 - 57
AT3147	140 x 70	132-140 / 66-70	1.129 €	1.291 €	1.411 €	60 - 65
AT3148	140 X 80	132-140 / 76-80	1.164 €	1.339 €	1.459 €	62 - 67
AT3149	140 X 90	132-140 / 86-90	1.176 €	1.351 €	1.471 €	62 - 67

SÓLO LATERAL

CÓDIGO	MEDIDA	RANGO DE INSTALACIÓN	TRANSPARENTE	DECORADO	
				GRUPO I	GRUPO II
AT307	70	66 - 70	413 €	497 €	542 €
AT308	80	76 - 80	452 €	537 €	582 €
AT309	90	86 - 90	480 €	565 €	610 €

ESPECIALES A MEDIDA SÓLO LATERAL

CÓDIGO	MEDIDA	TRANSPARENTE	DECORADO	
			GRUPO I	GRUPO II
ATS3070	HASTA 70	516 €	556 €	601 €
ATS3090	HASTA 90	577 €	626 €	671 €
ATS3110	HASTA 110	637 €	696 €	741 €

MAMPARA DE BAÑO SERIE ATEMPO 400

BATHROOM SCREEN ATEMPO 400 SERIES | ÉCRAN DE SALLE DE BAIN SÉRIE ATEMPO 400



MAMPARA ESTÁNDAR

CÓDIGO	MEDIDA	RANGO DE INSTALACIÓN	TRANSPARENTE	DECORADO		APERTURA
				GRUPO I	GRUPO II	
AT4127	120 x 70	116 - 122 / 67,5 - 70	1.032 €	1.190 €	1.280 €	46 - 52
AT4128	120 x 80	116 - 122 / 77,5 - 80	1.045 €	1.213 €	1.303 €	46 - 52
AT4137	130 x 70	126 - 132 / 67,5 - 70	1.064 €	1.223 €	1.313 €	46 - 52
AT4138	130 x 80	126 - 132 / 77,5 - 80	1.077 €	1.246 €	1.336 €	46 - 52
AT4147	140 x 70	132 - 142 / 67,5 - 70	1.089 €	1.249 €	1.339 €	53 - 62
AT4148	140 x 80	132 - 142 / 77,5 - 80	1.102 €	1.272 €	1.362 €	53 - 62
AT4157	150 x 70	142 - 152 / 67,5 - 70	1.106 €	1.304 €	1.424 €	53 - 62
AT4158	150 x 80	142 - 152 / 77,5 - 80	1.119 €	1.327 €	1.447 €	53 - 62
AT4167	160 x 70	152 - 162 / 67,5 - 70	1.127 €	1.333 €	1.453 €	58 - 67
AT4168	160 x 80	152 - 162 / 77,5 - 80	1.140 €	1.355 €	1.475 €	58 - 67
AT4177	170 x 70	162 - 172 / 67,5 - 70	1.141 €	1.360 €	1.480 €	58 - 67
AT4178	170 x 80	162 - 172 / 77,5 - 80	1.159 €	1.383 €	1.503 €	58 - 67
AT4187	180 x 70	172 - 182 / 67,5 - 70	1.164 €	1.412 €	1.532 €	58 - 67
AT4188	180 x 80	172 - 182 / 77,5 - 80	1.176 €	1.434 €	1.554 €	58 - 67

ESPECIALES A MEDIDA SÓLO LATERAL

CÓDIGO	MEDIDA	TRANSPARENTE	DECORADO	
			GRUPO I	GRUPO II
ATS4050	HASTA 50	357 €	385 €	430 €
ATS4070	HASTA 70	417 €	455 €	500 €
ATS4090	HASTA 90	478 €	525 €	570 €
ATS4110	HASTA 110	538 €	595 €	640 €

SÓLO LATERAL

CÓDIGO	MEDIDA	RANGO DE INSTALACIÓN	TRANSPARENTE	DECORADO	
				GRUPO I	GRUPO II
AT407	70	67,5-70	374 €	443 €	488 €
AT408	80	77,5-80	387 €	466 €	511 €
AT409	90	87,5-90	399 €	487 €	532 €

MAMPARA DE BAÑO SERIE ATEMPO 500

BATHROOM SCREEN ATEMPO 500 SERIES | ÉCRAN DE SALLE DE BAIN SÉRIE ATEMPO 500



MAMPARA ESTÁNDAR

CÓDIGO	MEDIDA	RANGO DE INSTALACIÓN	TRANSPARENTE	DECORADO		APERTURA
				GRUPO I	GRUPO II	
ATS160	160	152 - 162	667 €	809 €	899 €	58 - 67
ATS170	170	162 - 172	679 €	828 €	918 €	58 - 67

ESPECIALES A MEDIDA

CÓDIGO	MEDIDA	TRANSPARENTE	DECORADO	
			GRUPO I	GRUPO II
ATS5140	HASTA 140	867 €	928 €	973 €
ATS5160	HASTA 160	913 €	980 €	1.070 €
ATS5180	HASTA 180	958 €	1.033 €	1.123 €
ATS5200	HASTA 200	1.003 €	1.085 €	1.175 €
ATS5220	HASTA 220	1.049 €	1.138 €	1.228 €

DIMENSIONES MÁXIMAS MAMPARAS A MEDIDA

- Altura máxima 2200 mm
- Ancho máximo 3000 mm

ESPECIFICACIONES TRAMITACIÓN PEDIDOS

- Indicar medida de hueco real para adaptar la mejor opción y evitar errores de códigos
- Indicar posición de puerta mirando la mampara desde fuera (mano)
- Especificar cuando el plato este enrasado a suelo o sea de obra.

PLAZO DE EXPEDICIONES

- Transparentes 48 horas
- Decorados 5 días hábiles GRUPO 1 (EXCEPTO MATE Y PARSOLES)
- Cristales especiales y decorados (GRUPO 2, MATE Y PARSOLES) 15 días

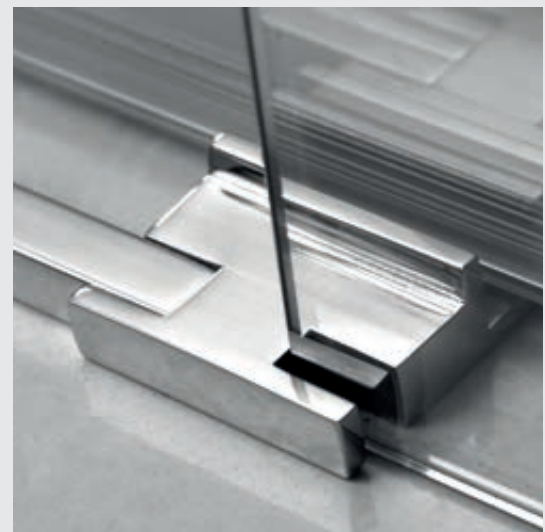



LUXURY





Modelo **LUXURY 100**. Mampara Frontal Corredera.



Modelo **LUXURY 900**. Mampara Frontal Corredera

MAMPARA DE BAÑO SERIE LUXURY 100

BATHROOM SCREEN LUXURY 100 SERIES | ÉCRAN DE SALLE DE BAIN SÉRIE LUXURY 100



MAMPARA ESTANDAR

CÓDIGO	MEDIDA	RANGO DE INSTALACIÓN	TRANSPARENTE	DECORADO		APERTURA
				GRUPO I	GRUPO II	
LX1100	100	97,5-102,5	494 €	571 €	616 €	40
LX1105	105	102,6-107,5	526 €	602 €	647 €	42
LX1110	110	107,6-112,5	534 €	610 €	655 €	45
LX1115	115	112,6-117,5	542 €	618 €	663 €	47
LX1120	120	117,6-122,5	550 €	626 €	671 €	50
LX1125	125	122,6-127,5	561 €	638 €	683 €	52
LX1130	130	127,6-132,5	573 €	649 €	694 €	55
LX1135	135	132,6-137,5	583 €	660 €	705 €	57
LX1140	140	137,6-142,5	591 €	668 €	713 €	60
LX1145	145	142,6-147,5	597 €	708 €	798 €	62
LX1150	150	147,6-152,5	614 €	729 €	819 €	65
LX1155	155	152,6-157,5	621 €	740 €	830 €	67
LX1160	160	157,6-162,5	627 €	749 €	839 €	70
LX1165	165	162,6-167,5	638 €	763 €	853 €	72
LX1170	170	167,6-172,5	642 €	772 €	862 €	75
LX1175	175	172,6-177,5	651 €	785 €	875 €	77
LX1180	180	177,6-182,5	657 €	794 €	884 €	80

ESPECIALES A MEDIDA

CÓDIGO	MEDIDA	TRANSPARENTE	DECORADO	
			GRUPO I	GRUPO II
LXS1120	HASTA 120	715 €	814 €	859 €
LXS1140	HASTA 140	769 €	868 €	913 €
LXS1160	HASTA 160	815 €	974 €	1.064 €
LXS1180	HASTA 180	854 €	1.033 €	1.123 €
LXS1200	HASTA 200	893 €	1.092 €	1.182 €
LXS1220	HASTA 220	932 €	1.150 €	1.240 €

MAMPARA DE BAÑO SERIE LUXURY 200

BATHROOM SCREEN LUXURY 200 SERIES | ÉCRAN DE SALLE DE BAIN SÉRIE LUXURY 200



MAMPARA ESTANDAR

CÓDIGO	MEDIDA	RANGO DE INSTALACIÓN	TRANSPARENTE	DECORADO		APERTURA
				GRUPO I	GRUPO II	
LX2160	160	157,6-162,5	698 €	850 €	940 €	64
LX2170	170	167,6-172,5	722 €	874 €	964 €	69
LX2180	180	177,6-182,5	745 €	897 €	987 €	74

ESPECIALES A MEDIDA

CÓDIGO	MEDIDA	TRANSPARENTE	DECORADO	
			GRUPO I	GRUPO II
LXS2140	HASTA 140	715 €	814 €	859 €
LXS2160	HASTA 160	769 €	868 €	913 €
LXS2180	HASTA 180	815 €	974 €	1.064 €
LXS2200	HASTA 200	854 €	1.033 €	1.123 €
LXS2220	HASTA 220	893 €	1.092 €	1.182 €

MAMPARA DE BAÑO SERIE LUXURY 300

BATHROOM SCREEN LUXURY 300 SERIES | ÉCRAN DE SALLE DE BAIN SÉRIE LUXURY 300



MAMPARA ESTANDAR

CÓDIGO	MEDIDA	RANGO DE INSTALACIÓN	TRANSPARENTE	DECORADO		APERTURA
				GRUPO I	GRUPO II	
LX3077	70X70	67,5-70 / 67,5-70	681 €	834 €	924 €	35
LX3088	80 x 80	77,5-80 / 77,5-80	716 €	869 €	959 €	42
LX3099	90 x 90	87,5-90 / 87,5-90	739 €	892 €	982 €	49
LX3087	80X70	77,5-80 / 67,5-70	699 €	851 €	941 €	39
LX3097	90X70	87,5-90 / 67,5-70	710 €	863 €	953 €	43
LX3098	90X80	87,5-90 / 77,5-80	728 €	880 €	970 €	46
LX3101	100 X 100	97,5-100 / 97,5-100	762 €	915 €	1.005 €	56
LX3107	100 x 70	97,5-100 / 67,5-70	722 €	874 €	964 €	51
LX3108	100 x 80	97,5-100 / 77,5-80	739 €	892 €	982 €	54
LX3109	100 X 90	97,5-100 / 87,5-90	751 €	903 €	993 €	53
LX3117	110 X 70	107,6-110 / 67,5-70	892 €	1.076 €	1.166 €	51
LX3118	110 x 80	107,6-110 / 77,5-80	909 €	1.061 €	1.151 €	54
LX3119	110 X 90	107,6-110 / 87,5-90	921 €	1.073 €	1.163 €	57
LX3127	120 x 70	117,6-120 / 67,5 - 70	908 €	1.048 €	1.138 €	55
LX3128	120 X 80	117,6-120 / 77,5 -80	925 €	1.078 €	1.168 €	58
LX3129	120 X 90	117,6-120 / 87,5-90	937 €	1.089 €	1.209 €	61
LX3137	130 x 70	127,6-130 / 67,5-70	931 €	1.071 €	1.191 €	60
LX3138	130 X 80	127,6-130 / 77,5-80	948 €	1.101 €	1.221 €	62
LX3139	130 X 90	127,6-130 / 87,5-90	960 €	1.112 €	1.232 €	65
LX3147	140 x 70	117,6-140 / 67,5-70	949 €	1.090 €	1.210 €	65
LX3148	140 X 80	117,6-140 / 77,5-80	967 €	1.119 €	1.239 €	67
LX3149	140 X 90	117,6-140 / 87,5-90	978 €	1.131 €	1.251 €	69

ESPECIALES A MEDIDA SÓLO LATERAL

CÓDIGO	MEDIDA	TRANSPARENTE	DECORADO	
			GRUPO I	GRUPO II
LXS3070	HASTA 70	465 €	565 €	610 €
LXS3090	HASTA 90	503 €	602 €	647 €
LXS3110	HASTA 110	541 €	640 €	685 €

SÓLO LATERAL

CÓDIGO	MEDIDA	RANGO DE INSTALACIÓN	TRANSPARENTE	DECORADO	
				GRUPO I	GRUPO II
LX307	70	67,5-70	358 €	434 €	479 €
LX308	80	77,5-80	375 €	452 €	497 €
LX309	90	87,5-90	387 €	463 €	508 €

MAMPARA DE BAÑO SERIE LUXURY 400

BATHROOM SCREEN LUXURY 400 SERIES | ÉCRAN DE SALLE DE BAIN SÉRIE LUXURY 400



MAMPARA ESTÁNDAR

CÓDIGO	MEDIDA	RANGO DE INSTALACIÓN	TRANSPARENTE	DECORADO		APERTURA
				GRUPO I	GRUPO II	
LX4127	120 x 70	117,5-120/ 68-69,5	885 €	1.019 €	1.109 €	46 - 52
LX4128	120 x 80	117,5-120/ 78-79,5	908 €	1.030 €	1.120 €	46 - 52
LX4137	130 x 70	127,5-130/68-69,5	908 €	1.042 €	1.132 €	46 - 52
LX4138	130 x 80	127,5-130/ 78-79,5	931 €	1.053 €	1.143 €	46 - 52
LX4147	140 x 70	137,5-140/68-69,5	926 €	1.060 €	1.150 €	53 - 62
LX4148	140 x 80	137,5-140/78-79,5	949 €	1.076 €	1.166 €	53 - 62
LX4157	150 x 70	147,5-150/68-69,5	961 €	1.122 €	1.242 €	53 - 62
LX4158	150 x 80	147,5-150/78-79,5	973 €	1.133 €	1.253 €	53 - 62
LX4167	160 x 70	157,5-160/68-69,5	962 €	1.142 €	1.262 €	58 - 67
LX4168	160 x 80	157,5-160/78-79,5	985 €	1.154 €	1.274 €	58 - 67
LX4177	170 x 70	167,5-170/68-69,5	977 €	1.164 €	1.314 €	58 - 67
LX4178	170 x 80	167,5-170/78-79,5	1.000 €	1.176 €	1.326 €	58 - 67
LX4187	180 x 70	177,5-180/68-79,5	992 €	1.187 €	1.337 €	58 - 67
LX4188	180 x 80	177,5-180/78-79,5	1.015 €	1.199 €	1.349 €	58 - 67

SÓLO LATERAL

CÓDIGO	MEDIDA	RANGO DE INSTALACIÓN	TRANSPARENTE	DECORADO	
				GRUPO I	GRUPO II
LX407	70	68-69,5	335 €	393 €	438 €
LX408	80	78-79,5	358 €	404 €	449 €
LX409	90	88-89,5	375 €	422 €	467 €

ESPECIALES A MEDIDA SÓLO LATERAL

CÓDIGO	MEDIDA	TRANSPARENTE	DECORADO	
			GRUPO I	GRUPO II
LXS4050	HASTA 50	417 €	474 €	519 €
LXS4070	HASTA70	437 €	516 €	561 €
LXS4090	HASTA90	487 €	602 €	647 €
LXS4110	HASTA110	549 €	683 €	728 €

MAMPARA DE BAÑO SERIE LUXURY 900

BATHROOM SCREEN LUXURY 900 SERIES | ÉCRAN DE SALLE DE BAIN SÉRIE LUXURY 900



MAMPARA ESTÁNDAR

CÓDIGO	MEDIDA	TRANSPARENTE	DECORADO	
			GRUPO I	GRUPO II
LX9160	HASTA 160	721 €	865 €	955 €
LX9180	HASTA 180	745 €	889 €	979 €
LX9200	HASTA 200	768 €	918 €	1.008 €
LX9220	HASTA 220	803 €	1.034 €	1.124 €

ESPECIALES A MEDIDA

CÓDIGO	MEDIDA	TRANSPARENTE	DECORADO	
			GRUPO I	GRUPO II
LXS9160	HASTA 160	865 €	1.038 €	1.128 €
LXS9180	HASTA 180	894 €	1.067 €	1.157 €
LXS9200	HASTA 200	922 €	1.102 €	1.192 €
LXS9220	HASTA 220	963 €	1.240 €	1.330 €

PLAZO DE ENTREGA 15 DÍAS

DIMENSIONES MÁXIMAS MAMPARAS A MEDIDA

- Altura máxima 2200 mm
- Ancho máximo 2200 mm

ESPECIFICACIONES TRAMITACIÓN PEDIDOS

- Indicar medida de hueco real para adaptar la mejor opción y evitar errores de códigos
- Indicar posición de puerta mirando la mampara desde fuera (mano)
- Especificar cuando el plato este enrasado a suelo o sea de obra.

PLAZO DE EXPEDICIONES

- Transparentes 48 horas
- Decorados 5 días hábiles GRUPO 1 (EXCEPTO MATE Y PARSOLES)
- Cristales especiales y decorados (GRUPO 2, MATE Y PARSOLES) 15 días

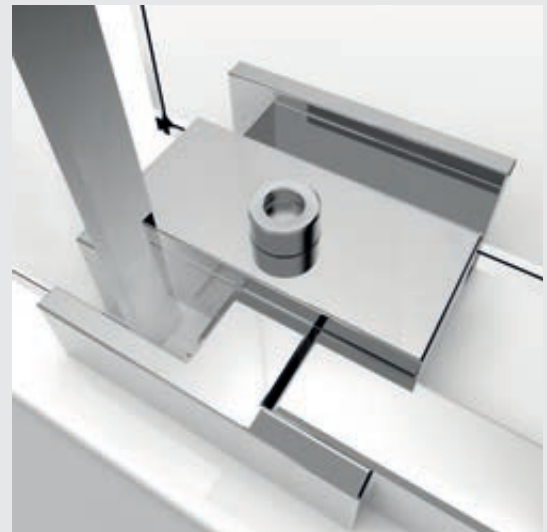



ELEGANT







Modelo **ELEGANT 100**. Mampara Frontal Corredera



Modelo **ELEGANT 300**. Mampara Angular Corredera. Entrada en vértice



Modelo **ELEGANT 300**. Mampara Angular Corredera sobre muro. Entrada vértice.



Modelo **ELEGANT 300**. Fijación perfil detrás de muro.



ESPEJOR CRISTALES

- Cristales fijos en 8 mm.
- Cristales puertas en 6 mm.

DIMENSIONES MÁXIMAS MAMPARAS A MEDIDA

- Altura máxima 2200 mm
- Ancho máximo 2200 mm

ESPECIFICACIONES TRAMITACIÓN PEDIDOS

- Indicar medida de hueco real para adaptar la mejor opción y evitar errores de códigos
- Indicar posición de puerta mirando la mampara desde fuera (mano)
- Especificar cuando el plato este enrasado a suelo o sea de obra.

PLAZO DE EXPEDICIONES

- Mampara totalmente a medida. Plazo de expedición en todas sus modalidades 15 días.
- Cristales especiales y decorados (GRUPO 2, MATE Y PARSOLES) 15 días

MAMPARA DE BAÑO SERIE ELEGANT 100

BATHROOM SCREEN ELEGANT 100 SERIES | ÉCRAN DE SALLE DE BAIN SÉRIE ELEGANT 100



MAMPARA ESTÁNDAR

CÓDIGO	MEDIDA	RANGO DE INSTALACIÓN	TRANSPARENTE	DECORADO		APERTURA
				GRUPO I	GRUPO II	
EL1100	100	97,5-102,5	478 €	558 €	603 €	38
EL1105	105	102,6-107,5	496 €	576 €	621 €	41
EL1110	110	107,6-112,5	502 €	582 €	627 €	43
EL1115	115	112,6-117,5	508 €	588 €	633 €	46
EL1120	120	117,6-122,5	514 €	594 €	639 €	48
EL1125	125	122,6-127,5	525 €	605 €	650 €	51
EL1130	130	127,6-132,5	532 €	612 €	657 €	53
EL1135	135	132,6-137,5	543 €	623 €	668 €	56
EL1140	140	117,6-142,5	554 €	634 €	679 €	58
EL1145	145	142,6-147,5	565 €	681 €	771 €	61
EL1150	150	147,6-152,5	571 €	691 €	781 €	63
EL1155	155	152,6-157,5	581 €	705 €	795 €	66
EL1160	160	157,6-162,5	587 €	715 €	805 €	68
EL1165	165	162,6-167,5	599 €	731 €	821 €	71
EL1170	170	167,6-172,5	605 €	741 €	831 €	73
EL1175	175	172,6-177,5	613 €	753 €	843 €	76
EL1180	180	177,6-182,5	623 €	767 €	857 €	78

ESPECIALES

CÓDIGO	MEDIDA	TRANSPARENTE	DECORADO	
			GRUPO I	GRUPO II
ELS1120	HASTA120	669 €	772 €	862 €
ELS1140	HASTA140	720 €	824 €	914 €
ELS1160	HASTA160	763 €	929 €	1.019 €
ELS1180	HASTA180	810 €	997 €	1.087 €
ELS1200	HASTA200	857 €	1.065 €	1.155 €
ELS1220	HASTA220	904 €	1.133 €	1.223 €

MAMPARA DE BAÑO SERIE ELEGANT 300

BATHROOM SCREEN ELEGANT 300 SERIES | ÉCRAN DE SALLE DE BAIN SÉRIE ELEGANT 300



MAMPARA ESTANDAR

CÓDIGO	MEDIDA	RANGO DE INSTALACIÓN	TRANSPARENTE	DECORADO		APERTURA
				GRUPO I	GRUPO II	
EL3077	70 x 70	67,5-70 / 67,5-70	678 €	837 €	927 €	37
EL3088	80 x 80	77,5-80 / 77,5-80	702 €	862 €	952 €	42
EL3099	90 x 90	87,5-90 / 87,5-90	726 €	886 €	976 €	47
EL3087	80 x 70	77,5-80 / 67,5-70	690 €	849 €	939 €	37
EL3097	90 x 70	87,5-90 / 67,5-70	702 €	862 €	952 €	41
EL3098	90 x 80	87,5-90 / 77,5-80	714 €	874 €	964 €	44
EL3101	100 x 100	97,5-100 / 97,5-100	768 €	928 €	1.018 €	52
EL3107	100 x 70	97,5-100 / 67,5-70	726 €	886 €	976 €	49
EL3108	100 x 80	97,5-100 / 77,5-80	738 €	898 €	988 €	52
EL3109	100 x 90	97,5-100 / 87,5-90	750 €	910 €	1.000 €	51
EL3117	110 x 70	107,6-110 / 67,5-70	835 €	1.028 €	1.118 €	49
EL3118	110 x 80	107,6-110 / 77,5-80	847 €	1.007 €	1.097 €	52
EL3119	110 x 90	107,6-110 / 87,5-90	859 €	1.019 €	1.109 €	55
EL3127	120 x 70	117,6-120 / 67,5-70	859 €	1.006 €	1.096 €	53
EL3128	120 x 80	117,6-120 / 77,5-80	871 €	1.031 €	1.121 €	57
EL3129	120 x 90	117,6-120 / 87,5-90	883 €	1.043 €	1.163 €	59
EL3137	130 x 70	127,6-130 / 67,5-70	871 €	1.018 €	1.138 €	58
EL3138	130 x 80	127,6-130 / 77,5-80	883 €	1.043 €	1.163 €	60
EL3139	130 x 90	127,6-130 / 87,5-90	895 €	1.055 €	1.175 €	63
EL3147	140 x 70	137,6-140 / 67,5-70	889 €	1.036 €	1.156 €	63
EL3148	140 x 80	137,6-140 / 77,5-80	901 €	1.061 €	1.181 €	65
EL3149	140 x 90	137,6-140 / 87,5-90	914 €	1.073 €	1.193 €	67

ESPECIALES SÓLO LATERAL

CÓDIGO	MEDIDA	TRANSPARENTE	DECORADO	
			GRUPO I	GRUPO II
ELS3070	HASTA70	464 €	568 €	658 €
ELS3090	HASTA90	495 €	599 €	689 €
ELS3110	HASTA110	527 €	631 €	721 €

SÓLO LATERAL ESTANDAR

CÓDIGO	MEDIDA	RANGO DE INSTALACIÓN	TRANSPARENTE	DECORADO	
				GRUPO I	GRUPO II
EL307	70	67,5-70	357 €	437 €	527 €
EL308	80	77,5-80	369 €	449 €	539 €
EL309	90	87,5-90	381 €	461 €	551 €
EL310	100	97,5-100	405 €	485 €	575 €

FREE







Modelo **FREE 400**. Mampara Angular Corredera. Entrada frontal.



Modelo **FREE 200B**. Mampara Frontal Corredera decorado LOFT.



Modelo **FREE 200B**. Mampara Frontal Corredera. Decorado **TAIGA**

DIMENSIONES MÁXIMAS MAMPARAS A MEDIDA

- Altura máxima 2200 mm
- Ancho máximo 2200 mm

ESPECIFICACIONES TRAMITACIÓN PEDIDOS

- Indicar medida de hueco real para adaptar la mejor opción y evitar errores de códigos
- Indicar posición de puerta mirando la mampara desde fuera (mano)
- Especificar cuando el plato este enrasado a suelo o sea de obra.

PLAZO DE EXPEDICIONES

- Transparentes 48 horas
- Decorados 5 días hábiles GRUPO 1 (EXCEPTO MATE Y PARSOLES)
- Cristales especiales y decorados (GRUPO 2, MATE Y PARSOLES) 15 días

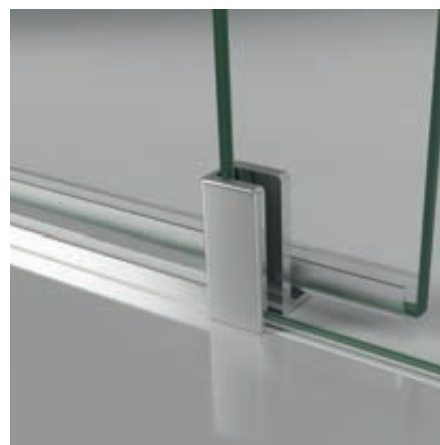
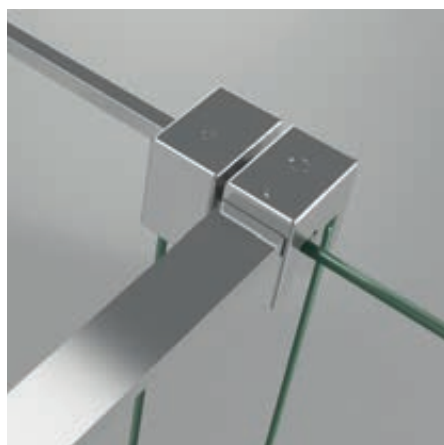
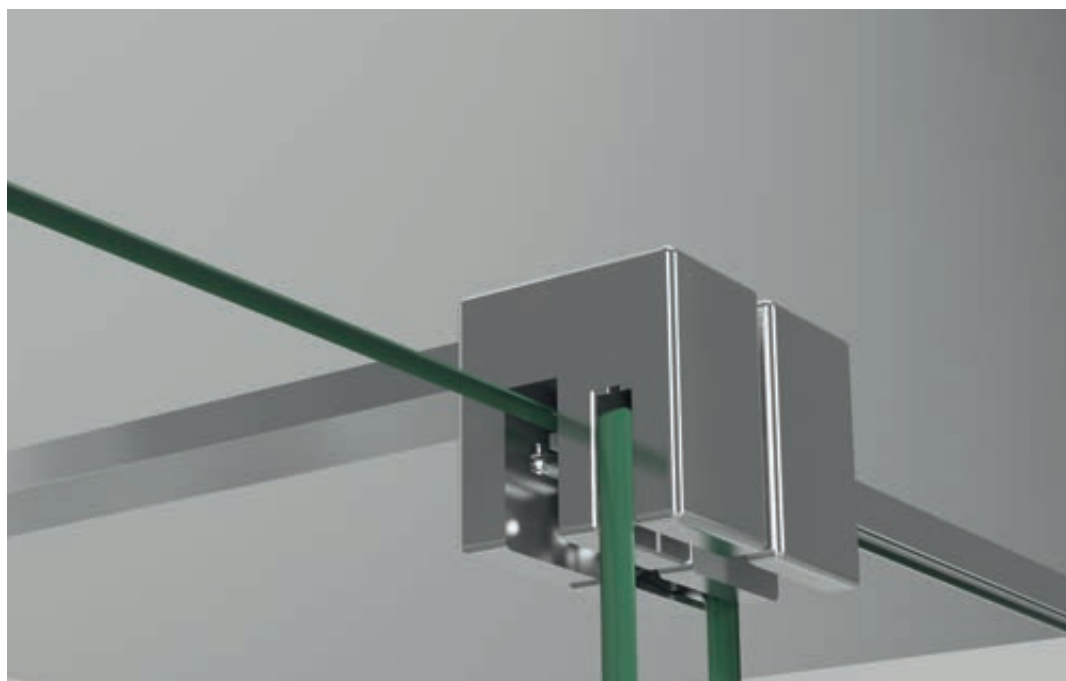

MAMPARA DE BAÑO SERIE FREE 100

BATHROOM SCREEN FREE 100 SERIES | ÉCRAN DE SALLE DE BAIN SÉRIE FREE 100



MAMPARA ESTANDAR

CÓDIGO	MEDIDA	RANGO DE INSTALACIÓN	POSICION BARRA	TRANSPARENTE	DECORADO		APERTURA
					GRUPO I	GRUPO II	
FR1110	110	107,6-112,5	535	545 €	653 €	698 €	39-44
FR1115	115	112,6-117,5	535	553 €	661 €	706 €	39-44
FR1120	120	117,6-122,5	585	561 €	669 €	714 €	43-49
FR1125	125	122,6-127,5	585	573 €	681 €	726 €	43-49
FR1130	130	127,6-132,5	635	584 €	692 €	737 €	49-54
FR1135	135	132,6-137,5	635	595 €	739 €	784 €	49-54
FR1140	140	117,6-142,5	685	603 €	747 €	792 €	54-59
FR1145	145	142,6-147,5	685	609 €	752 €	842 €	54-59
FR1150	150	147,6-152,5	735	627 €	771 €	861 €	59-64
FR1155	155	152,6-157,5	735	633 €	777 €	867 €	59-64
FR1160	160	157,6-162,5	785	639 €	782 €	872 €	64-69
FR1165	165	162,6-167,5	835	649 €	793 €	883 €	64-69
FR1170	170	167,6-172,5	885	654 €	797 €	887 €	69-74
FR1175	175	172,6-177,5	935	663 €	830 €	920 €	69-74
FR1180	180	177,6-182,5	985	669 €	836 €	926 €	74-79

ESPECIALES A MEDIDA

CÓDIGO	MEDIDA	TRANSPARENTE	DECORADO	
			GRUPO I	GRUPO II
FRS1120	HASTA 120	728 €	814 €	859 €
FRS1140	HASTA 140	783 €	868 €	913 €
FRS1160	HASTA 160	831 €	974 €	1.064 €
FRS1180	HASTA 180	871 €	1.033 €	1.123 €
FRS1200	HASTA 200	910 €	1.092 €	1.182 €
FRS1220	HASTA 220	950 €	1.150 €	1.240 €

MAMPARA DE BAÑO SERIE FREE 500

BATHROOM SCREEN FREE 500 SERIES | ÉCRAN DE SALLE DE BAIN SÉRIE FREE 500



MAMPARA ESTANDAR

CÓDIGO	MEDIDA	TRANSPARENTE	DECORADO	
			GRUPO I	GRUPO II
FR5120	HASTA 120	525 €	634 €	679 €
FR5130	HASTA 130	549 €	711 €	756 €

ESPECIALES A MEDIDA

CÓDIGO	MEDIDA	TRANSPARENTE	DECORADO	
			GRUPO I	GRUPO II
FRS5140	HASTA 140	714 €	1.038 €	1.083 €
FRS5160	HASTA 160	734 €	1.067 €	1.157 €
FRS5180	HASTA 180	754 €	1.102 €	1.192 €
FRS5200	HASTA 200	774 €	1.240 €	1.330 €
FRS5215	HASTA 215	515 €	639 €	639 €

MAMPARA DE BAÑO SERIE FREE 400

BATHROOM SCREEN FREE 400 SERIES | ÉCRAN DE SALLE DE BAIN SÉRIE FREE 400



MAMPARA ESTÁNDAR

CÓDIGO	MEDIDA	RANGO DE INSTALACIÓN	POSICION BARRA	TRANSPARENTE	DECORADO		APERTURA
					GRUPO I	GRUPO II	
FR4127	120 x 70	116 - 122 / 67,5 - 70	585	896 €	1.061 €	1.151 €	46 - 52
FR4128	120 x 80	116 - 122 / 77,5 - 80	585	919 €	1.090 €	1.180 €	46 - 52
FR4137	130 x 70	126 - 132 / 67,5 - 70	635	919 €	1.085 €	1.175 €	46 - 52
FR4138	130 x 80	126 - 132 / 77,5 - 80	635	942 €	1.113 €	1.203 €	46 - 52
FR4147	140 x 70	132 - 142 / 67,5 - 70	685	942 €	1.139 €	1.229 €	53 - 62
FR4148	140 x 80	132 - 142 / 77,5 - 80	685	961 €	1.156 €	1.246 €	53 - 62
FR4157	150 x 70	142 - 152 / 67,5 - 70	735	962 €	1.163 €	1.283 €	53 - 62
FR4158	150 x 80	142 - 152 / 77,5 - 80	735	985 €	1.192 €	1.312 €	53 - 62
FR4167	160 x 70	152 - 162 / 67,5 - 70	785	985 €	1.175 €	1.295 €	58 - 67
FR4168	160 x 80	152 - 162 / 77,5 - 80	785	997 €	1.204 €	1.324 €	58 - 67
FR4177	170 x 70	162 - 172 / 67,5 - 70	885	997 €	1.190 €	1.310 €	58 - 67
FR4178	170 x 80	162 - 172 / 77,5 - 80	885	1.012 €	1.219 €	1.339 €	58 - 67
FR4187	180 x 70	172 - 182 / 67,5 - 70	985	1.012 €	1.228 €	1.348 €	58 - 67
FR4188	180 x 80	172 - 182 / 77,5 - 80	985	1.027 €	1.257 €	1.377 €	58 - 67

ESPECIALES A MEDIDA SÓLO LATERAL

CÓDIGO	MEDIDA	TRANSPARENTE	DECORADO	
			GRUPO I	GRUPO II
FRS405	HASTA 50	395 €	474 €	519 €
FRS407	HASTA 70	435 €	516 €	561 €
FRS409	HASTA 90	480 €	602 €	647 €
FRS411	HASTA 110	540 €	683 €	728 €

SÓLO LATERAL

CÓDIGO	MEDIDA	RANGO DE INSTALACIÓN	TRANSPARENTE	DECORADO	
				GRUPO I	GRUPO II
FR407	70	68-70	335 €	393 €	438 €
FR408	80	78-80	358 €	422 €	467 €
FR409	90	88-90	375 €	439 €	484 €

MAMPARA DE BAÑO SERIE FREE 800

BATHROOM SCREEN FREE 800 SERIES | ÉCRAN DE SALLE DE BAIN SÉRIE FREE 800

ESPECIALES A MEDIDA

CÓDIGO	MEDIDA	TRANSPARENTE	DECORADO	
			GRUPO I	GRUPO II
FRS805	HASTA 50	425 €	504 €	548 €
FRS807	HASTA 70	465 €	546 €	591 €

ESPECIALES A MEDIDA

CÓDIGO	MEDIDA	TRANSPARENTE	DECORADO	
			GRUPO I	GRUPO II
FRS809	HASTA 90	510 €	632 €	677 €
FRS811	HASTA 110	570 €	712 €	758 €

MAMPARA DE BAÑO SERIE FREE 900

BATHROOM SCREEN FREE 900 SERIES | ÉCRAN DE SALLE DE BAIN SÉRIE FREE 900

PLAZO DE EXPEDICIÓN 15 DÍAS



MAMPARA ESTÁNDAR

CÓDIGO	MEDIDA	TRANSPARENTE	DECORADO	
			GRUPO I	GRUPO II
FR9160	HASTA 160	754 €	878 €	968 €
FR9180	HASTA 180	784 €	923 €	1.013 €
FR9200	HASTA 200	830 €	998 €	1.088 €
FR9220	HASTA 220	877 €	1.065 €	1.155 €

ESPECIALES A MEDIDA

CÓDIGO	MEDIDA	TRANSPARENTE	DECORADO	
			GRUPO I	GRUPO II
FRS9160	HASTA 160	882 €	1.038 €	1.128 €
FRS9180	HASTA 180	911 €	1.067 €	1.157 €
FRS9200	HASTA 200	939 €	1.102 €	1.192 €
FRS9215	HASTA 215	982 €	1.240 €	1.330 €

URBAN

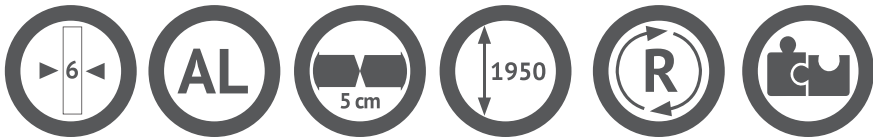





Modelo **URBAN 100**. Mampara Frontal Corredera.



Modelo **URBAN 200 + LATERAL 800**. Mampara Angular Corredera. Entrada Frontal.

MAMPARA DE BAÑO SERIE URBAN 100

BATHROOM SCREEN URBAN 100 SERIES | ÉCRAN DE SALLE DE BAIN SÉRIE URBAN 100



MAMPARA ESTANDAR

CÓDIGO	MEDIDA	RANGO DE INSTALACIÓN	TRANSPARENTE	DECORADO		APERTURA
				GRUPO I	GRUPO II	
UR1100	100	97,5-102,5	367 €	451 €	496 €	38
UR1105	105	102,6-107,5	377 €	460 €	505 €	40
UR1110	110	107,6-112,5	386 €	469 €	514 €	43
UR1115	115	112,6-117,5	396 €	480 €	525 €	47
UR1120	120	117,6-122,5	406 €	490 €	535 €	48
UR1125	125	122,6-127,5	417 €	502 €	547 €	52
UR1130	130	127,6-132,5	429 €	513 €	558 €	53
UR1135	135	132,6-137,5	434 €	518 €	563 €	57
UR1140	140	137,6-142,5	438 €	523 €	568 €	58
UR1145	145	142,6-147,5	447 €	551 €	641 €	62
UR1150	150	147,6-152,5	456 €	580 €	670 €	63
UR1155	155	152,6-157,5	462 €	590 €	680 €	67
UR1160	160	157,6-162,5	468 €	599 €	689 €	68
UR1165	165	162,6-167,5	483 €	618 €	708 €	72
UR1170	170	167,6-172,5	497 €	636 €	726 €	73
UR1175	175	172,6-177,5	533 €	677 €	767 €	77

ESPECIALES A MEDIDA

CÓDIGO	MEDIDA	TRANSPARENTE	DECORADO	
			GRUPO I	GRUPO II
URS1120	HASTA 120	497 €	587 €	632 €
URS1140	HASTA 140	528 €	632 €	677 €
URS1160	HASTA 160	559 €	677 €	767 €
URS1180	HASTA 180	589 €	722 €	812 €
URS1200	HASTA 200	620 €	767 €	857 €
URS1220	HASTA 220	651 €	812 €	902 €

MAMPARA DE BAÑO SERIE URBAN 200

BATHROOM SCREEN URBAN 200 SERIES | ÉCRAN DE SALLE DE BAIN SÉRIE URBAN 200



MAMPARA ESTANDAR

CÓDIGO	MEDIDA	RANGO DE INSTALACIÓN	TRANSPARENTE	DECORADO		APERTURA
				GRUPO I	GRUPO II	
UR2140	140	135 - 140	478 €	640 €	685 €	51
UR2150	150	145 - 150	492 €	654 €	744 €	56
UR2160	160	155 - 160	504 €	667 €	757 €	61
UR2170	170	165 - 170	522 €	685 €	775 €	66
UR2180	180	175 - 180	540 €	703 €	793 €	71

ESPECIALES A MEDIDA

CÓDIGO	MEDIDA	TRANSPARENTE	DECORADO	
			GRUPO I	GRUPO II
URS2140	HASTA 140	586 €	692 €	737 €
URS2160	HASTA 160	615 €	735 €	825 €
URS2180	HASTA 180	644 €	778 €	868 €
URS2200	HASTA 200	673 €	821 €	911 €
URS2220	HASTA 220	702 €	864 €	954 €

MAMPARA DE BAÑO SERIE URBAN 300

BATHROOM SCREEN URBAN 300 SERIES | ÉCRAN DE SALLE DE BAIN SÉRIE URBAN 300



MAMPARA ESTANDAR

CÓDIGO	MEDIDA	RANGO DE INSTALACIÓN	TRANSPARENTE	DECORADO		APERTURA
				GRUPO I	GRUPO II	
UR3077	70x70	67,5-70/67,5-70	480 €	642 €	732 €	35
UR3088	80 x 80	77,5-80/77,5-80	528 €	691 €	781 €	40
UR3099	90 x 90	88,5-90/88,5-90	564 €	728 €	818 €	45
UR3087	80 x 70	77,5-80 / 67,5-70	504 €	667 €	757 €	38
UR3097	90 x 70	88,5-90 / 67,5-70	522 €	685 €	775 €	40
UR3098	90 x 80	88,5-90 / 77,5-80	546 €	710 €	800 €	42
UR3101	100 x 100	96,5-99/96,5-99	588 €	752 €	842 €	48
UR3107	100 x 70	96,5-99/67,5-70	552 €	716 €	806 €	45
UR3108	100 x 80	96,5-99/77,5-80	576 €	740 €	830 €	48
UR3109	100 x 90	96,5-99/87,5-90	594 €	758 €	848 €	51
UR3117	110 x 70	106,5-109/67,5-70	619 €	787 €	877 €	49
UR3118	110 x 80	106,5-109/77,5-80	631 €	795 €	885 €	52
UR3119	110 x 90	106,5-109/87,5-90	637 €	801 €	891 €	55
UR3127	120 x 70	116,5-119/67,5-70	631 €	783 €	873 €	53
UR3128	120 x 80	116,5-119/77,5-80	643 €	807 €	897 €	55
UR3129	120 x 90	116,5-119/88,5-90	661 €	826 €	946 €	56
UR3137	130 x 70	126,5-129/67,5-70	663 €	816 €	936 €	56
UR3138	130 x 80	126,5-129/77,5-80	673 €	838 €	958 €	59
UR3139	130 x 90	126,5-129/88,5-90	691 €	856 €	976 €	61
UR3147	140 x 70	136,5-139/67,5-70	679 €	832 €	952 €	62
UR3148	140 x 80	136,5-139/77,5-80	697 €	863 €	983 €	65
UR3149	140 x 90	136,5-139/88,5-90	715 €	881 €	1.001 €	67

ESPECIALES A MEDIDA SÓLO LATERAL

CÓDIGO	MEDIDA	TRANSPARENTE	DECORADO	
			GRUPO I	GRUPO II
URS307	HASTA 70	340 €	394 €	439 €
URS309	HASTA 90	370 €	439 €	484 €
URS311	HASTA 110	402 €	484 €	529 €

SÓLO LATERAL

CÓDIGO	MEDIDA	RANGO DE INSTALACIÓN	TRANSPARENTE	DECORADO	
				GRUPO I	GRUPO II
UR307	70	67,5-70	240 €	308 €	353 €
UR308	80	77,5-80	264 €	345 €	390 €
UR309	90	87,5-90	282 €	364 €	409 €

MAMPARA DE BAÑO SERIE URBAN 400

BATHROOM SCREEN URBAN 400 SERIES | ÉCRAN DE SALLE DE BAIN SÉRIE URBAN 400



MAMPARA ESTANDAR

CÓDIGO	MEDIDA	RANGO DE INSTALACIÓN	TRANSPARENTE	DECORADO		APERTURA
				GRUPO I	GRUPO II	
UR4127	120 x 70	116,5-119/67,5-70	612 €	763 €	853 €	48
UR4128	120 x 80	116,5-119/77,5-80	631 €	791 €	881 €	48
UR4137	130 x 70	126,5-129/67,5-70	631 €	705 €	795 €	53
UR4138	130 x 80	126,5-129/77,5-80	649 €	809 €	899 €	53
UR4147	140 x 70	136,5-139/67,5-70	655 €	806 €	896 €	58
UR4148	140 x 80	136,5-139/77,5-80	673 €	833 €	923 €	58
UR4157	150 x 70	146,5-149/67,5-70	673 €	862 €	982 €	63
UR4158	150 x 80	146,5-149/77,5-80	691 €	890 €	1.010 €	63
UR4167	160 x 70	156,5-159/67,5-70	691 €	888 €	1.008 €	68
UR4168	160 x 80	156,5-159/77,5-80	709 €	916 €	1.036 €	68
UR4177	170 x 70	166,5-169/67,5-70	709 €	919 €	1.039 €	73
UR4178	170 x 80	166,5-169/77,5-80	727 €	942 €	1.062 €	73

ESPECIALES A MEDIDA SÓLO LATERAL

CÓDIGO	MEDIDA	TRANSPARENTE	DECORADO	
			GRUPO I	GRUPO II
URS405	HASTA 50	228 €	267 €	312 €
URS407	HASTA 70	257 €	310 €	355 €
URS409	HASTA 90	286 €	353 €	398 €
URS411	HASTA 110	315 €	396 €	441 €

SÓLO LATERAL

CÓDIGO	MEDIDA	RANGO DE INSTALACIÓN	TRANSPARENTE	DECORADO	
				GRUPO I	GRUPO II
UR407	70	67,5-70	207 €	273 €	318 €
UR408	80	77,5-80	225 €	301 €	346 €
UR409	90	87,5-90	242 €	321 €	366 €

MAMPARA DE BAÑO SERIE URBAN 700

BATHROOM SCREEN URBAN 700 SERIES | ÉCRAN DE SALLE DE BAIN SÉRIE URBAN 700

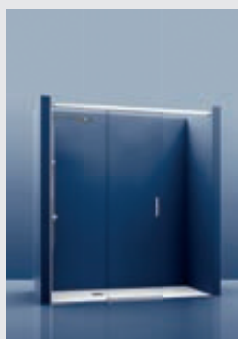

MAMPARA ESTANDAR

CÓDIGO	MEDIDA	RANGO DE INSTALACIÓN	TRANSPARENTE	DECORADO		APERTURA
				GRUPO I	GRUPO II	
UR7100	100	96,5-99	424 €	509 €	554 €	38
UR7105	105	101,5-104	433 €	558 €	603 €	40
UR7110	110	106,5-109	442 €	527 €	572 €	43
UR7115	115	111,5-114	452 €	551 €	596 €	47
UR7120	120	116,5-119	462 €	548 €	593 €	48
UR7125	125	121,5-124	474 €	572 €	617 €	52
UR7130	130	126,5-129	485 €	571 €	616 €	53
UR7135	135	131,5-134	491 €	620 €	665 €	57
UR7140	140	136,5-139	495 €	581 €	626 €	58

ESPECIALES A MEDIDA

CÓDIGO	MEDIDA	TRANSPARENTE	DECORADO	
			GRUPO I	GRUPO II
URS7120	HASTA 120	553 €	645 €	690 €
URS7140	HASTA 140	577 €	683 €	728 €
URS7160	HASTA 160	602 €	722 €	812 €

MAMPARA DE BAÑO SERIE URBAN 800

BATHROOM SCREEN URBAN 800 SERIES | ÉCRAN DE SALLE DE BAIN SÉRIE URBAN 800



MAMPARA ESTANDAR

CÓDIGO	MEDIDA	RANGO DE INSTALACIÓN	TRANSPARENTE	DECORADO		APERTURA
				GRUPO I	GRUPO II	
UR80777	70x70x70	67,5-70/67,5-70	820 €	962 €	1.082 €	35
UR80888	80x80x80	77,5-80/77,5-80	838 €	1.030 €	1.150 €	40
UR80999	90x90x90	88,5-90/88,5-90	927 €	1.088 €	1.208 €	45
UR80877	80x70x70	77,5-80 / 67,5-70	844 €	986 €	1.106 €	38
UR80977	90x70x70	88,5-90 / 67,5-70	862 €	1.005 €	1.125 €	40
UR80988	90x80x80	88,5-90 / 77,5-80	784 €	1.049 €	1.169 €	42
UR81011	100x100x100	97,5-100/97,5-100	980 €	1.145 €	1.265 €	48
UR81077	100x70x70	97,5-100/67,5-70	892 €	1.035 €	1.155 €	45
UR81088	100x80x80	97,5-100/77,5-80	814 €	1.079 €	1.199 €	48
UR81099	100x90x90	97,5-100/88,5-90	957 €	1.118 €	1.238 €	51
UR81177	110x70x70	106-109/67,5-70	958 €	1.106 €	1.226 €	49
UR81188	110x80x80	106-109/77,5-80	868 €	1.135 €	1.255 €	52
UR81199	110x90x90	106-109/88,5-90	999 €	1.161 €	1.281 €	55
UR81277	120x70x70	116-119/67,5-70	970 €	1.103 €	1.223 €	53
UR81289	120x80x80	116-119/77,5-80	880 €	1.147 €	1.267 €	55
UR1299	120x90x90	116-119/88,5-90	1.023 €	1.186 €	1.306 €	56
UR81377	130x70x90	126-129/67,5-70	970 €	1.097 €	1.217 €	56
UR81388	130x80x80	126-129/77,5-80	886 €	1.143 €	1.263 €	59
UR81399	130x90x90	126-129/88,5-90	1.017 €	1.147 €	1.267 €	61
UR81477	140x70x90	136-139/67,5-70	1.018 €	1.152 €	1.272 €	62
UR81488	140x80x80	136-139/77,5-80	934 €	1.202 €	1.322 €	65
UR81499	140x90x90	136-139/88,5-90	1.077 €	1.241 €	1.361 €	67

ESPECIALES A MEDIDA SÓLO LATERAL

CÓDIGO	MEDIDA	TRANSPARENTE	DECORADO	
			GRUPO I	GRUPO II
URS805	HASTA 50	318 €	358 €	403 €
URS807	HASTA 70	342 €	396 €	441 €
URS809	HASTA 90	367 €	435 €	480 €
URS811	HASTA 110	391 €	473 €	518 €

MAMPARA DE BAÑO SERIE URBAN 900

BATHROOM SCREEN URBAN 900 SERIES | ÉCRAN DE SALLE DE BAIN SÉRIE URBAN 900

PLAZO DE EXPEDICIÓN 15 DÍAS



MAMPARA ESTANDAR

CÓDIGO	MEDIDA	TRANSPARENTE	DECORADO	
			GRUPO I	GRUPO II
UR9160	HASTA 160	549 €	674 €	764 €
UR9180	HASTA 180	574 €	745 €	835 €
UR9200	HASTA 200	598 €	787 €	877 €
UR9220	HASTA 220	622 €	830 €	920 €

ESPECIALES A MEDIDA

CÓDIGO	MEDIDA	TRANSPARENTE	DECORADO	
			GRUPO I	GRUPO II
URS9160	HASTA 160	647 €	768 €	858 €
URS9180	HASTA 180	671 €	806 €	896 €
URS9200	HASTA 200	696 €	845 €	935 €
URS9220	HASTA 220	720 €	883 €	973 €

URBAN

DIMENSIONES MÁXIMAS MAMPARAS A MEDIDA

- Altura máxima 2200 mm
- Ancho máximo 2500 mm

ESPECIFICACIONES TRAMITACIÓN PEDIDOS

- Indicar medida de hueco real para adaptar la mejor opción y evitar errores de códigos
- Indicar posición de puerta mirando la mampara desde fuera (mano)
- Especificar cuando el plato este enrasado a suelo o sea de obra.
- El precio del tratamiento antical por cada hoja será de 10 euros.

PLAZO DE EXPEDICIONES

- Transparentes 48 horas
- Decorados 5 días hábiles GRUPO 1 (EXCEPTO MATE Y PARSOLES)
- Cristales especiales y decorados (GRUPO 2, MATE Y PARSOLES) 15 días

SLIM

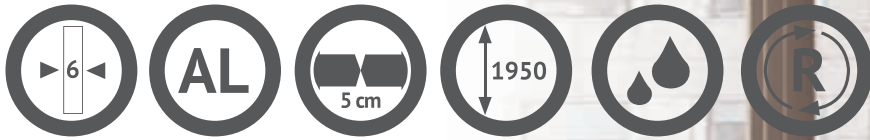





Modelo **SLIM 100**. Mampara Frontal Corredera. Perfilera **Negra**



Modelo **SLIM 400 ESPECIAL**. Mampara Angular Corredera. Fijo sobre muro. Entrada Frontal

MAMPARA DE BAÑO SERIE SLIM 100

BATHROOM SCREEN SLIM 100 SERIES | ÉCRAN DE SALLE DE BAIN SÉRIE SLIM 100

**INCREMENTO PERFILERÍA COLORES**NEGRO  + 45€

MAMPARA ESTANDAR

CÓDIGO	MEDIDA	RANGO DE INSTALACIÓN	TRANSPARENTE	DECORADO		APERTURA
				GRUPO I	GRUPO II	
SL1100	100	95-99	388 €	496 €	541 €	37-42
SL1105	105	100-104	395 €	503 €	548 €	40-44
SL1110	110	105-109	403 €	511 €	556 €	42-47
SL1115	115	110-114	411 €	519 €	564 €	44-49
SL1120	120	115-119	419 €	527 €	572 €	48-52
SL1125	125	120-124	427 €	535 €	580 €	50-54
SL1130	130	125-129	435 €	543 €	588 €	53-57
SL1135	135	130-134	444 €	551 €	596 €	55-59
SL1140	140	135-139	452 €	559 €	604 €	58-62
SL1145	145	140-144	460 €	603 €	693 €	60-64
SL1150	150	145-149	468 €	612 €	702 €	63-67
SL1155	155	150-154	475 €	618 €	708 €	65-69
SL1160	160	155-159	483 €	627 €	717 €	68-72
SL1165	165	160-164	487 €	631 €	721 €	70-79
SL1170	170	165-169	500 €	644 €	734 €	73-77
SL1175	175	170-174	508 €	652 €	742 €	73-77
SL1180	180	175-179	516 €	678 €	768 €	73-77

ESPECIALES A MEDIDA

CÓDIGO	MEDIDA	TRANSPARENTE	DECORADO	
			GRUPO I	GRUPO II
SLS1100	HASTA 100	485 €	620 €	665 €
SLS1120	HASTA 120	524 €	659 €	704 €
SLS1140	HASTA 140	565 €	699 €	744 €
SLS1160	HASTA 160	603 €	783 €	873 €
SLS1180	HASTA 180	645 €	847 €	937 €

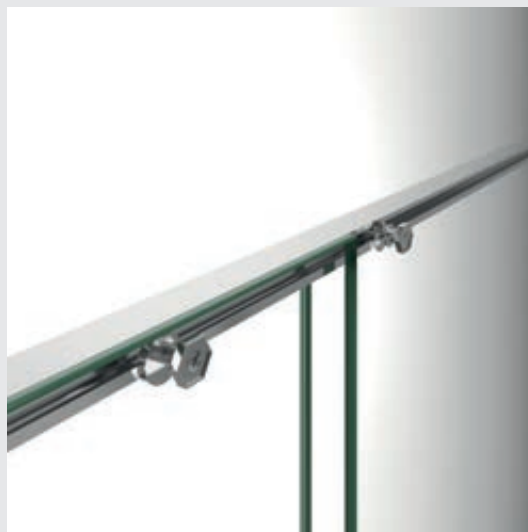

MAMPARA DE BAÑO SERIE SLIM 400

BATHROOM SCREEN SLIM 400 SERIES | ÉCRAN DE SALLE DE BAIN SÉRIE SLIM 400



INCREMENTO PERFILERÍA COLORES

NEGRO  + 65€

MAMPARA ESTANDAR

CÓDIGO	MEDIDA	RANGO DE INSTALACIÓN	TRANSPARENTE	DECORADO		APERTURA
				GRUPO I	GRUPO II	
SL4127	120x70	116-119/67,5-70	685 €	847 €	937 €	48
SL4128	120x80	116-119/77,5-80	696 €	876 €	966 €	48
SL4137	130x70	126-129/67,5-70	701 €	863 €	953 €	53
SL4138	130x80	126-129/77,5-80	713 €	892 €	982 €	53
SL4147	140x70	136-139/67,5-70	717 €	879 €	969 €	58
SL4148	140x80	136-139/77,5-80	729 €	908 €	998 €	58
SL4157	150x70	146-149/67,5-70	733 €	931 €	1.051 €	63
SL4158	150x80	146-149/77,5-80	745 €	961 €	1.081 €	63
SL4167	160x70	156-159/67,5-70	748 €	946 €	1.066 €	68
SL4168	160x80	156-159/77,5-80	760 €	976 €	1.096 €	68
SL4177	170x70	166-169/67,5-70	766 €	963 €	1.083 €	73
SL4178	170x80	166-169/77,5-80	777 €	993 €	1.113 €	73

SÓLO LATERAL

CÓDIGO	MEDIDA	RANGO DE INSTALACIÓN	TRANSPARENTE	DECORADO	
				GRUPO I	GRUPO II
SL407	70	67,5-70	266 €	320 €	365 €
SL408	80	77,5-80	277 €	349 €	394 €
SL409	90	87,5-90	289 €	361 €	406 €

ESPECIALES A MEDIDA SÓLO LATERAL

CÓDIGO	MEDIDA	TRANSPARENTE	DECORADO	
			GRUPO I	GRUPO II
SLS407	HASTA 70	332 €	399 €	444 €
SLS408	HASTA 80	347 €	436 €	481 €
SLS409	HASTA 90	361 €	451 €	496 €

DIMENSIONES MÁXIMAS MAMPARAS A MEDIDA

- Altura máxima 2200 mm
- Ancho máximo 2200 mm

ESPECIFICACIONES TRAMITACIÓN PEDIDOS

- Indicar medida de hueco real para adaptar la mejor opción y evitar errores de códigos
- Indicar posición de puerta mirando la mampara desde fuera (mano)
- Especificar cuando el plato este enrasado a suelo o sea de obra.

PLAZO DE EXPEDICIONES

- Transparentes 48 horas
- Decorados 5 días hábiles GRUPO 1 (EXCEPTO MATE Y PARSOLES)
- Cristales especiales y decorados (GRUPO 2, MATE Y PARSOLES) 15 días





COSMOS

COSMOS

6 AL 5 cm 1950

Icons: A circle with a vertical line and arrows indicating a width of 6; a circle with the text 'AL'; a circle with a horizontal line and arrows indicating a depth of 5 cm; a circle with a vertical line and arrows indicating a height of 1950; a circle with a water drop icon; a circle with a circular arrow and the letter 'R'.



Modelo **COSMOS 300**. Mampara Angular Corredera. Perifería **ORO ROSA**. Entrada vértice.



Modelo **COSMOS 700**. Mampara Frontal Corredera. Perifería **ORO BRILLO**.



Modelo **COSMOS Z**. Separador de estancias. Frontal con **2 entradas independientes**. Cristales **Transparentes** y cristales **MATE**. Perfilera color **NEGRO**.



Modelo **COSMOS Z + PADEL P00**. Separador de estancias. Frontal con **2 entradas independientes**. Cristales **Transparentes** y cristales **MATE**. Perfilería color **PLATA**.

MAMPARA DE BAÑO SERIE COSMOS 100





BATHROOM SCREEN COSMOS 100 SERIES | ÉCRAN DE SALLE DE BAIN SÉRIE COSMOS 100



MAMPARA ESTANDAR

CÓDIGO	MEDIDA	RANGO DE INSTALACIÓN	TRANSPARENTE	DECORADO		APERTURA PUERTA
				GRUPO I	GRUPO II	
CS1100	100	95-99	312 €	387 €	432 €	37-42
CS1105	105	99-104	320 €	395 €	440 €	40-44
CS1110	110	105-109	328 €	403 €	448 €	42-47
CS1115	115	110-114	336 €	410 €	455 €	44-49
CS1120	120	115-119	343 €	418 €	463 €	48-52
CS1125	125	120-124	351 €	426 €	471 €	50-54
CS1130	130	125-129	359 €	434 €	479 €	53-57
CS1135	135	130-134	367 €	442 €	487 €	55-59
CS1140	140	135-139	375 €	449 €	494 €	58-62
CS1145	145	140-144	383 €	491 €	581 €	60-64
CS1150	150	145-149	390 €	502 €	592 €	63-67
CS1155	155	150-154	398 €	514 €	604 €	65-69
CS1160	160	155-159	406 €	526 €	616 €	68-72
CS1165	165	160-164	414 €	538 €	628 €	70-79
CS1170	170	165-169	423 €	550 €	640 €	73-77
CS1175	175	170-174	431 €	561 €	651 €	73-77
CS1180	180	175-179	438 €	573 €	663 €	73-77

INCREMENTO PERFILERÍA COLORES

NEGRO  + 45€	ORO MATE  + 150€	ORO BRILLO  + 150€
BLANCO  + 150€	ORO ROSA  +150€	

ESPECIALES A MEDIDA

CÓDIGO	MEDIDA	TRANSPARENTE	DECORADO	
			GRUPO I	GRUPO II
CSS1120	HASTA 120	461 €	602 €	647 €
CSS1140	HASTA 140	492 €	656 €	701 €
CSS1160	HASTA 160	523 €	710 €	800 €
CSS1180	HASTA 180	554 €	765 €	855 €
CSS1200	HASTA 200	585 €	819 €	909 €
CSS1215	HASTA 215	616 €	873 €	963 €

MAMPARA DE BAÑO SERIE COSMOS 200

BATHROOM SCREEN COSMOS 200 SERIES | ÉCRAN DE SALLE DE BAIN SÉRIE COSMOS 200







MAMPARA ESTANDAR

CÓDIGO	MEDIDA	RANGO DE INSTALACIÓN	TRANSPARENTE	DECORADO		APERTURA PUERTA
				GRUPO I	GRUPO II	
CS2140	140	130 - 139	466 €	616 €	661 €	51 - 56
CS2150	150	140 - 149	479 €	629 €	719 €	56 - 61
CS2160	160	150 - 159	492 €	642 €	732 €	61 - 66
CS2170	170	160 - 169	510 €	660 €	750 €	66 - 71

ESPECIALES A MEDIDA

CÓDIGO	MEDIDA	TRANSPARENTE	DECORADO	
			GRUPO I	GRUPO II
CSS2140	HASTA 140	558 €	722 €	767 €
CSS2160	HASTA 160	587 €	775 €	865 €
CSS2180	HASTA 180	616 €	827 €	917 €
CSS2200	HASTA 200	645 €	880 €	970 €
CSS2215	HASTA 215	674 €	932 €	1.022 €

INCREMENTO PERFILERÍA COLORES

NEGRO  + 65€	ORO MATE  + 200€	ORO BRILLO  + 200€
BLANCO  + 200€	ORO ROSA  +200€	

MAMPARA DE BAÑO SERIE COSMOS 300

BATHROOM SCREEN COSMOS 300 SERIES | ÉCRAN DE SALLE DE BAIN SÉRIE COSMOS 300



MAMPARA ESTANDAR

CÓDIGO	MEDIDA	RANGO DE INSTALACIÓN	TRANSPARENTE	DECORADO		APERTURA PUERTA
				GRUPO I	GRUPO II	
CS3077	70x70	65-70/65-70	456 €	606 €	696 €	35-38
CS3088	80x80	75-80/75-80	528 €	678 €	768 €	40-43
CS3099	90x90	85-90/85-90	564 €	714 €	804 €	45-48
CS3087	80X70	75-80/65-70	492 €	642 €	732 €	36-41
CS3097	90X70	85-90/65-70	510 €	660 €	750 €	38-42
CS3098	90X80	85-90/75-80	546 €	696 €	786 €	42-46
CS3101	100X100	95-100/95-100	625 €	774 €	864 €	50-52
CS3107	100X70	95-100/65-70	540 €	690 €	780 €	39-45
CS3108	100X80	95-100/75-80	576 €	726 €	816 €	42-48
CS3109	100X90	95-100/85-90	594 €	744 €	834 €	46-50
CS3117	110x70	101-110/65-70	547 €	706 €	796 €	40-49
CS3118	110x80	101-110/75-80	592 €	742 €	832 €	43-52
CS3119	110x90	101-110/85-90	610 €	760 €	850 €	46-55
CS3127	120x70	111-120/65-70	584 €	721 €	811 €	46-53
CS3128	120x80	111-120/75-80	608 €	757 €	847 €	46-55
CS3129	120x90	111-120/85-90	626 €	775 €	865 €	47-56
CS3137	130x70	121-130/65-70	599 €	737 €	827 €	47-56
CS3138	130x80	121-130/75-80	623 €	773 €	863 €	50-59
CS3139	130x90	121-130/85-90	641 €	791 €	911 €	52-61
CS3147	140x70	131-140/65-70	615 €	752 €	872 €	53-62
CS3148	140x80	131-140/75-80	639 €	788 €	908 €	56-65
CS3149	140x90	131-140/85-90	657 €	806 €	926 €	58-67
CS3157	150x70	141-150/65-70	632 €	805 €	925 €	58-67
CS3158	150x80	141-150/75-80	656 €	841 €	961 €	61-70
CS3159	150x90	141-150/85-90	674 €	859 €	979 €	62-72

COSMOS

ESPECIALES A MEDIDA SÓLO LATERAL

CÓDIGO	MEDIDA	RANGO DE INSTALACIÓN	TRANSPARENTE	DECORADO	
				GRUPO I	GRUPO II
CSS307	70	65-70	325 €	385 €	430 €
CSS308	80	75-80	340 €	407 €	452 €
CSS309	90	85-90	355 €	461 €	506 €

SÓLO LATERAL

CÓDIGO	MEDIDA	RANGO DE INSTALACIÓN	TRANSPARENTE	DECORADO	
				GRUPO I	GRUPO II
CS307	70	65-70	228 €	303 €	348 €
CS308	80	75-80	264 €	339 €	384 €
CS309	90	85-90	282 €	357 €	402 €

INCREMENTO PERFILERÍA COLORES

- NEGRO + 65€
- ORO MATE + 200€
- ORO BRILLO + 200€
- BLANCO + 200€
- ORO ROSA +200€

MAMPARA DE BAÑO SERIE COSMOS 400

BATHROOM SCREEN COSMOS 400 SERIES | ÉCRAN DE SALLE DE BAIN SÉRIE COSMOS 400



MAMPARA ESTANDAR

CÓDIGO	MEDIDA	RANGO DE INSTALACIÓN	TRANSPARENTE	DECORADO		APERTURA PUERTA
				GRUPO I	GRUPO II	
CS4127	120x70	112-119/67,5-70	550 €	686 €	776 €	43-52
CS4128	120x80	112-119/77,5-80	568 €	702 €	792 €	43-52
CS4137	130x70	122-129/67,5-70	566 €	627 €	717 €	48-57
CS4138	130x80	122-129/77,5-80	584 €	717 €	807 €	48-57
CS4147	140x70	132-139/67,5-70	581 €	717 €	807 €	53-62
CS4148	140x80	132-139/77,5-80	599 €	733 €	823 €	53-62
CS4157	150x70	142-149/67,5-70	598 €	771 €	891 €	58-67
CS4158	150x80	142-149/77,5-80	616 €	787 €	907 €	58-67
CS4167	160x70	152-159/67,5-70	614 €	795 €	915 €	63-72
CS4168	160x80	152-159/77,5-80	632 €	810 €	930 €	63-72
CS4177	170x70	162-169/67,5-70	629 €	822 €	942 €	68-77
CS4178	170x80	162-169/77,5-80	647 €	833 €	953 €	68-77





ESPECIALES A MEDIDA SÓLO LATERAL

CÓDIGO	MEDIDA	TRANSPARENTE	DECORADO	
			GRUPO I	GRUPO II
CSS405	HASTA 50	228 €	287 €	332 €
CSS407	HASTA 70	257 €	339 €	384 €
CSS409	HASTA 90	286 €	392 €	437 €
CSS410	HASTA 110	315 €	444 €	489 €

SÓLO LATERAL

CÓDIGO	MEDIDA	RANGO DE INSTALACIÓN	TRANSPARENTE	DECORADO	
				GRUPO I	GRUPO II
CSS407	70	67,5-70	207 €	268 €	313 €
CSS408	80	77,5-80	225 €	283 €	328 €
CSS409	90	88,7-90	242 €	304 €	349 €

INCREMENTO PERFILERÍA COLORES

NEGRO 	+ 65€	ORO MATE 	+ 200€	ORO BRILLO 	+ 200€
BLANCO 	+ 200€	ORO ROSA 	+ 200€		

MAMPARA DE BAÑO SERIE COSMOS 700

BATHROOM SCREEN COSMOS 700 SERIES | ÉCRAN DE SALLE DE BAIN SÉRIE COSMOS 700

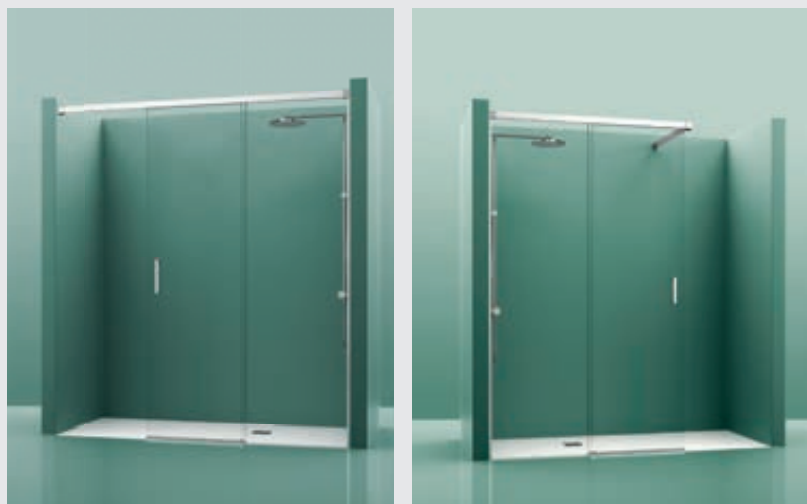





MAMPARA ESTANDAR

CÓDIGO	MEDIDA	RANGO DE INSTALACIÓN	TRANSPARENTE	DECORADO	
				GRUPO I	GRUPO II
CS7100	100	98	369 €	444 €	489 €
CS7105	105	103	377 €	451 €	496 €
CS7110	110	108	385 €	459 €	504 €
CS7115	115	113	392 €	467 €	512 €
CS7120	120	118	400 €	475 €	520 €
CS7125	125	123	408 €	483 €	528 €
CS7130	130	128	416 €	491 €	536 €
CS7135	135	133	424 €	498 €	543 €
CS7140	140	138	431 €	506 €	551 €

ESPECIALES A MEDIDA

CÓDIGO	MEDIDA	TRANSPARENTE	DECORADO	
			GRUPO I	GRUPO II
CSS7120	HASTA 120	453 €	594 €	639 €
CSS7140	HASTA 140	478 €	642 €	687 €
CSS7160	HASTA 160	502 €	690 €	780 €

INCREMENTO PERFILERÍA COLORES

NEGRO 	+ 45€	ORO MATE 	+ 150€	ORO BRILLO 	+ 150€
BLANCO 	+ 150€	ORO ROSA 	+ 150€		

MAMPARA DE BAÑO SERIE COSMOS 800

BATHROOM SCREEN COSMOS 800 SERIES | ÉCRAN DE SALLE DE BAIN SÉRIE COSMOS 800



MAMPARA ESTANDAR





CÓDIGO	MEDIDA	RANGO DE INSTALACIÓN	TRANSPARENTE	DECORADO		APERTURA PUERTA
				GRUPO I	GRUPO II	
CS80777	70x70X70	67,5-70/67,5-70	717 €	928 €	1.018 €	35
CS80888	80x80X80	77,5-80/77,5-80	800 €	1.020 €	1.110 €	40
CS80999	90x90X90	88,5-90/88,5-90	848 €	1.077 €	1.197 €	45
CS80877	80X70X70	77,5-80 / 67,5-70	753 €	964 €	1.084 €	38
CS80977	90X70X70	88,5-90 / 67,5-70	771 €	982 €	1.102 €	40
CS80988	90X80X80	88,5-90 / 77,5-80	818 €	1.038 €	1.158 €	42
CS81011	100X100X100	97,5-100/97,5-100	919 €	1.069 €	1.189 €	48
CS81077	100x70X70	97,5-100/67,5-70	801 €	1.012 €	1.132 €	45
CS81088	100x80X80	97,5-100/77,5-80	848 €	1.068 €	1.188 €	48
CS81099	100x90X90	97,5-100/88,5-90	878 €	1.107 €	1.227 €	51
CS81177	110x70X70	106-109/67,5-70	813 €	1.027 €	1.147 €	49
CS81188	110x80X80	106-109/77,5-80	864 €	1.084 €	1.204 €	52
CS81199	110x90X90	106-109/88,5-90	893 €	1.122 €	1.242 €	55
CS81277	120x70X70	116-119/67,5-70	844 €	1.043 €	1.163 €	53
CS81289	120x80X80	116-119/77,5-80	880 €	1.099 €	1.219 €	55
CS1299	120x90X90	116-119/88,5-90	909 €	1.138 €	1.288 €	56
CS81377	130x70X90	126-129/67,5-70	860 €	1.059 €	1.209 €	56
CS81388	130x80X80	126-129/77,5-80	895 €	1.115 €	1.265 €	59
CS81399	130x90X90	126-129/88,5-90	925 €	1.153 €	1.303 €	61
CS81477	140x70X90	136-139/67,5-70	875 €	1.074 €	1.224 €	62
CS81488	140x80X80	136-139/77,5-80	911 €	1.131 €	1.281 €	65
CS81499	140x90x90	136-139/88,5-90	940 €	1.169 €	1.319 €	67

COSMOS

ESPECIALES A MEDIDA SÓLO LATERAL

CÓDIGO	MEDIDA	TRANSPARENTE	DECORADO	
			GRUPO I	GRUPO II
CSS805	HASTA 50	271 €	318 €	363 €
CSS807	HASTA 70	318 €	365 €	410 €
CSS809	HASTA 90	342 €	413 €	458 €
CSS811	HASTA 110	362 €	462 €	507 €

INCREMENTO PERFILERÍA COLORES

NEGRO  + 65€ ORO MATE  + 200€ ORO BRILLO  + 200€
 BLANCO  + 200€ ORO ROSA  +200€

SÓLO LATERAL

CÓDIGO	MEDIDA	RANGO DE INSTALACIÓN	TRANSPARENTE	DECORADO	
				GRUPO I	GRUPO II
CS8070	70	67,5-70	261 €	322 €	367 €
CS8080	80	87,5-80	272 €	342 €	387 €
CS8090	90	87,5-90	283 €	363 €	408 €
CS8100	100	97,5-100	295 €	385 €	430 €

MAMPARA DE BAÑO SERIE COSMOS 500





BATHROOM SCREEN COSMOS 500 SERIES | ÉCRAN DE SALLE DE BAIN SÉRIE COSMOS 500

ESPECIALES A MEDIDA



CÓDIGO	MEDIDA	TRANSPARENTE	DECORADO	
			GRUPO I	GRUPO II
CSS5140	HASTA 140	452 €	594 €	639 €
CSS5160	HASTA 160	475 €	639 €	729 €
CSS5180	HASTA 180	497 €	679 €	769 €
CSS5200	HASTA 200	520 €	713 €	803 €
CSS5215	HASTA 215	532 €	738 €	828 €

INCREMENTO PERFILERÍA COLORES

NEGRO  + 45€ ORO MATE  + 150€ ORO BRILLO  + 150€
 BLANCO  + 150€ ORO ROSA  +150€

MAMPARA DE BAÑO SERIE COSMOS 900

BATHROOM SCREEN COSMOS 900 SERIES | ÉCRAN DE SALLE DE BAIN SÉRIE COSMOS 900

PLAZO DE EXPEDICIÓN 15 DÍAS







MAMPARA ESTANDAR

CÓDIGO	MEDIDA	TRANSPARENTE	DECORADO	
			GRUPO I	GRUPO II
CS9160	HASTA160	516 €	628 €	718 €
CS9180	HASTA180	540 €	697 €	787 €
CS9200	HASTA200	565 €	739 €	829 €
CS9220	HASTA220	589 €	781 €	871 €

ESPECIALES A MEDIDA

CÓDIGO	MEDIDA	TRANSPARENTE	DECORADO	
			GRUPO I	GRUPO II
CSS9160	HASTA160	576 €	703 €	793 €
CSS9180	HASTA180	610 €	751 €	841 €
CSS9200	HASTA200	676 €	799 €	889 €
CSS9215	HASTA220	706 €	847 €	937 €

INCREMENTO PERFILERÍA COLORES

NEGRO 	+ 45€	ORO MATE 	+ 150€	ORO BRILLO 	+ 150€
BLANCO 	+ 150€	ORO ROSA 	+ 150€		

MAMPARA DE BAÑO SERIE COSMOS Z SUITE

BATHROOM SCREEN COSMOSZ SUITE SERIES | ÉCRAN DE SALLE DE BAIN SÉRIE COSMOS Z SUITE





PLAZO DE EXPEDICIÓN 15 DÍAS



MAMPARA A MEDIDA

CÓDIGO	MEDIDA	TRANSPARENTE	DECORADO	
			GRUPO I	GRUPO II
CSZS250	HASTA250	980 €	1.084 €	1.188 €
CSZS300	HASTA 300	1.066 €	1.170 €	1.274 €
CSZS350	HASTA 350	1.141 €	1.245 €	1.349 €
CSZS400	HASTA 400	1.217 €	1.321 €	1.425 €

INCREMENTO PERFILERÍA COLORES

NEGRO 	+ 90€	ORO MATE 	+ 300€	ORO BRILLO 	+ 300€
BLANCO 	+ 300€	ORO ROSA 	+ 300€		

MAMPARA DE BAÑO SERIE COSMOS Z MIXTA

BATHROOM SCREEN COSMOS Z MIXTA SERIES | ÉCRAN DE SALLE DE BAIN SÉRIE COSMOS Z MIXTA

PLAZO DE EXPEDICIÓN 15 DÍAS



MAMPARA A MEDIDA

CÓDIGO	MEDIDA	TRANSPARENTE	DECORADO	
			GRUPO I	GRUPO II
CSZM200	HASTA 200	1.084 €	1.416 €	1.570 €
CSZM250	HASTA 250	1.175 €	1.506 €	1.660 €
CSZM300	HASTA 300	1.265 €	1.596 €	1.750 €
CSZM350	HASTA 350	1.355 €	1.686 €	1.840 €
CSZM400	HASTA 400	1.445 €	1.776 €	1.930 €

INCREMENTO ESTANTES 30 EUROS POR BALDA
 * TODOS LOS SOPORTES DE BALDAS EN COLOR CROMO

INCREMENTO PERFILERÍA COLORES

- NEGRO + 90€
- ORO MATE + 300€
- ORO BRILLO + 300€
- BLANCO + 300€
- ORO ROSA +300€

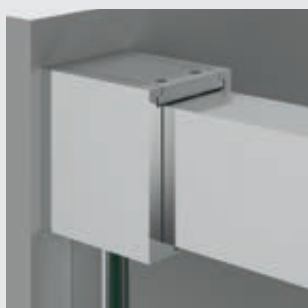

OPCIONAL

- Perfil regulación "U" 2,5 cm. 30 €. Acabado plata. Resto de colores 40 €.

DIMENSIONES MÁXIMAS MAMPARAS A MEDIDA

- Altura máxima 2200 mm
- Ancho máximo 2500 mm

ESPECIFICACIONES TRAMITACIÓN PEDIDOS

- Indicar medida de hueco real para adaptar la mejor opción y evitar errores de códigos
- Indicar posición de puerta mirando la mampara desde fuera (mano)
- Especificar cuando el plato este enrasado a suelo o sea de obra.

PLAZO DE EXPEDICIONES

- Transparentes 48 horas
- Decorados 5 días hábiles GRUPO 1 (EXCEPTO MATE Y PARSOLES)
- Cristales especiales y decorados (GRUPO 2, MATE Y PARSOLES) 15 días





ECO





Modelo **ECO 100**. Mampara Frontal Corredera.



Modelo **ECO 200**. Mampara Frontal Corredera.

MAMPARA DE BAÑO SERIE ECO 100

BATHROOM SCREEN ECO 100 SERIES | ÉCRAN DE SALLE DE BAIN SÉRIE ECO 100



MAMPARA ESTANDAR

CÓDIGO	MEDIDA	RANGO DE INSTALACIÓN	TRANSPARENTE	DECORADO	APERTURA
				RAYAS	
ECO1100	100	97,5 - 102,5	326 €	350 €	38
ECO1105	105	102,5 - 107,5	333 €	358 €	40
ECO1110	110	107,5 - 112,5	341 €	365 €	43
ECO1115	115	112,5 - 117,5	343 €	367 €	45
ECO1120	120	117,5 - 122,5	346 €	370 €	48
ECO1125	125	122,5 - 127,5	355 €	379 €	50
ECO1130	130	127,5 - 132,5	362 €	387 €	50
ECO1135	135	132,5 - 137,5	370 €	394 €	52
ECO1140	140	137,5 - 142,5	377 €	401 €	55
ECO1145	145	142,5 - 147,5	383 €	407 €	57
ECO1150	150	147,5 - 152,5	390 €	415 €	60
ECO1155	155	152,5 - 157,5	406 €	430 €	62
ECO1160	160	157,5 - 162,5	423 €	447 €	62
ECO1165	165	162,5 - 167,5	440 €	464 €	65
ECO1170	170	167,5 - 172,5	455 €	479 €	67
ECO1175	175	172,5 - 177,5	473 €	497 €	70
ECO1180	180	177,5 - 182,5	491 €	515 €	72

MAMPARA DE BAÑO SERIE ECO 200

BATHROOM SCREEN ECO 200 SERIES | ÉCRAN DE SALLE DE BAIN SÉRIE ECO 200



MAMPARA ESTANDAR

CÓDIGO	MEDIDA	RANGO DE INSTALACIÓN	TRANSPARENTE	DECORADO	APERTURA
				RAYAS	
ECO2140	140	135 - 140	444 €	468 €	53
ECO2150	150	145 - 150	468 €	492 €	58
ECO2160	160	155 - 160	480 €	504 €	63
ECO2170	170	165 - 170	492 €	516 €	68
ECO2180	180	175 - 180	499 €	524 €	73
ECO2190	190	185 - 190	523 €	547 €	78
ECO2200	200	195 - 200	541 €	565 €	83

MAMPARA DE BAÑO SERIE ECO 300

BATHROOM SCREEN ECO 300 SERIES | ÉCRAN DE SALLE DE BAIN SÉRIE ECO 300



MAMPARA ESTANDAR

CÓDIGO	MEDIDA	RANGO DE INSTALACIÓN	TRANSPARENTE	DECORADO	APERTURA
				RAYAS	
ECO3077	70x70	67-69,5/67-69,5	441 €	490 €	38
ECO3088	80x80	77-79,5/77-79,5	456 €	504 €	41
ECO3099	90x90	87-89,5/87-89,5	478 €	526 €	44
ECO3101	100x100	97,5-102,5/97,5-102,5	485 €	533 €	54
ECO3087	80x70	77-79,5/67-69,5	449 €	497 €	48
ECO3097	90x70	87-89,5/67-69,5	459 €	508 €	41
ECO3098	90x80	87-89,5/77-79,5	467 €	515 €	50
ECO3107	100x70	97-99,5/67-69,5	463 €	512 €	45
ECO3108	100x80	97-99,5/77-79,5	470 €	519 €	48
ECO3109	100x90	97-99,5/87-89,5	481 €	530 €	51
ECO3117	110x70	107-109,5/67-69,5	561 €	610 €	50
ECO3118	110x80	107-109,5/77-79,5	569 €	617 €	53
ECO3119	110x90	107-109,5/87-89,5	579 €	628 €	56
ECO3127	120x70	117-119,5/67-69,5	475 €	524 €	55
ECO3128	120x80	117-119,5/77-79,5	482 €	531 €	58
ECO3129	120x90	117-119,5/87-89,5	493 €	542 €	61
ECO3137	130x70	127-129,5/67-69,5	583 €	632 €	56
ECO3138	130x80	127-129,5/77-79,5	590 €	639 €	58
ECO3139	130x90	127-129,5/87-89,5	601 €	650 €	61
ECO3147	140x70	137-139,5/67-69,5	598 €	646 €	60
ECO3148	140x80	137-139,5/77-79,5	605 €	653 €	68
ECO3149	140x90	137-139,5/87-89,5	616 €	664 €	69

MAMPARA DE BAÑO SERIE ECO 400

BATHROOM SCREEN ECO 400 SERIES | ÉCRAN DE SALLE DE BAIN SÉRIE ECO 400



MAMPARA ESTANDAR

CÓDIGO	MEDIDA	RANGO DE INSTALACIÓN	TRANSPARENTE	DECORADO	APERTURA
				RAYAS	
ECO4127	120x70	117-119,5/67-69,5	556 €	593 €	50
ECO4128	120x80	117-119,5/77-79,5	573 €	610 €	50
ECO4129	120x90	117-119,5/87-89,5	595 €	632 €	50
ECO4137	130x70	127-129,5/67-69,5	573 €	610 €	52
ECO4138	130x80	127-129,5/77-79,5	590 €	627 €	52
ECO4139	130x90	127-129,5/87-89,5	612 €	649 €	52
ECO4147	140x70	137-139,5/67-69,5	588 €	624 €	57
ECO4148	140x80	137-139,5/77-79,5	605 €	641 €	57
ECO4149	140x90	137-139,5/87-89,5	627 €	663 €	57
ECO4157	150x70	147-149,5/67-69,5	601 €	638 €	62
ECO4158	150x80	147-149,5/77-79,5	618 €	655 €	62
ECO4159	150x90	147-149,5/87-89,5	640 €	676 €	62
ECO4167	160x70	157-159,5/67-69,5	634 €	670 €	63
ECO4168	160x80	157-159,5/77-79,5	651 €	687 €	63
ECO4169	160x90	157-159,5/87-89,5	673 €	709 €	63
ECO4177	170x70	167-169,5/67-69,5	666 €	702 €	68
ECO4178	170x80	167-169,5/77-79,5	683 €	719 €	68
ECO4179	170x90	167-169,5/87-89,5	704 €	741 €	68

MAMPARA DE BAÑO SERIE ECO 600

BATHROOM SCREEN ECO 600 SERIES | ÉCRAN DE SALLE DE BAIN SÉRIE ECO 600



MAMPARA ESTANDAR

CÓDIGO	MEDIDA	RANGO DE INSTALACIÓN	TRANSPARENTE	DECORADO		APERTURA
				RAYAS		
ECO6080	80X80	77,5-80	444 €	480 €		46
ECO6090	90X90	87,5-90	462 €	498 €		50



PLAZO DE EXPEDICIONES

- Transparente y Decorado 48 horas
- Decorado SÓLO DECORADO RAYAS



Modelo **ECO 600 SEMICIRCULAR**. Mampara Angular Corredera.
Radio **ROCA**



TOP







Modelo **TOP 100**. Mampara Frontal Corredera.



Detalle Guiador inferior

Modelo **TOP 400**. Mampara Angular Corredera. Entrada Frontal.

MAMPARA DE BAÑO SERIE TOP 100

BATHROOM SCREEN TOP 100 SERIES | ÉCRAN DE SALLE DE BAIN SÉRIE TOP 100



MAMPARA ESTANDAR

CÓDIGO	MEDIDA	RANGO DE INSTALACIÓN	TRANSPARENTE	APERTURA
TP1100	100	97-100	240 €	39
TP1103	103	100-103	247 €	41
TP1106	106	103-106	260 €	42
TP1109	109	106-109	274 €	44
TP1112	112	109-112	280 €	45
TP1115	115	112-115	284 €	47
TP1118	118	115-118	288 €	48
TP1121	121	118-121	291 €	50
TP1124	124	121-124	295 €	51
TP1127	127	124-127	298 €	53
TP1130	130	127-130	301 €	54
TP1133	133	130-133	305 €	56
TP1136	136	133-136	308 €	57
TP1139	139	136-139	312 €	59
TP1142	142	139-142	314 €	60
TP1145	145	142-145	318 €	62
TP1148	148	145-148	320 €	63
TP1151	151	148-151	322 €	65
TP1154	154	151-154	325 €	66
TP1157	157	154-157	327 €	68
TP1160	160	157-160	329 €	69

MAMPARA DE BAÑO SERIE TOP 300

BATHROOM SCREEN TOP 300 SERIES | ÉCRAN DE SALLE DE BAIN SÉRIE TOP 300



MAMPARA ESTANDAR

CÓDIGO	MEDIDA	RANGO DE INSTALACIÓN	TRANSPARENTE	APERTURA
TP3077	70x70	67,5 - 69 / 67,5 - 69	335 €	35
TP3088	80x80	77,5 - 79 / 77,5 - 79	351 €	41
TP3099	90x90	87,5 - 89 / 87,5 - 89	252 €	48
TP3087	80x70	77,5 - 79 / 67,5 - 69	343 €	38
TP3097	90x70	87,5 - 89 / 67,5 - 69	351 €	41
TP3098	90x80	87,5 - 89 / 77,5 - 79	359 €	44
TP3107	100x70	97,5 - 99 / 67,5 - 69	355 €	45
TP3108	100x80	97,5 - 99 / 77,5 - 79	363 €	48
TP3109	100x90	97,5 - 99 / 87,5 - 89	371 €	51
TP3117	110x70	107,5 - 109 / 67,5 - 69	378 €	50
TP3118	110x80	107,5 - 109 / 77,5 - 79	386 €	53
TP3119	110x90	107,5 - 109 / 88,5 - 89	394 €	56
TP3127	120x70	117,5 - 119 / 67,5 - 69	390 €	55
TP3128	120x80	117,5 - 119 / 77,5 - 79	398 €	58

SÓLO LATERAL

CÓDIGO	MEDIDA	RANGO DE INSTALACIÓN	TRANSPARENTE
TP307	70	67,5 - 69	167 €
TP308	80	77,5 - 79	176 €
TP309	90	87,5 - 89	184 €

MAMPARA DE BAÑO SERIE TOP 400

BATHROOM SCREEN TOP 400 SERIES | ÉCRAN DE SALLE DE BAIN SÉRIE TOP 400



MAMPARA ESTANDAR

CÓDIGO	MEDIDA	RANGO DE INSTALACIÓN	TRANSPARENTE	APERTURA
TP4127	120X70	116,5-119/67,5-70	460 €	48
TP4128	120X80	116,5-119/77,5-80	471 €	48
TP4137	130X70	125,5-129/67,5-70	474 €	53
TP4147	130X80	125,5-129/77,5-80	485 €	53
TP4148	140X70	136,5-139/67,5-70	484 €	58
TP4147	140X8	136,5-139/77,5-80	495 €	58
TP4157	150X70	146,5-149/67,5-70	492 €	63
TP4158	150X80	146,5-149/77,5-80	504 €	63
TP4167	160X70	156,5-159/67,5-70	501 €	68
TP4168	160X80	156,5-159/77,5-80	513 €	68

SÓLO LATERAL

CÓDIGO	MEDIDA	RANGO DE INSTALACIÓN	TRANSPARENTE
TP407	70	67,5 - 69	172 €
TP408	80	77,5 - 79	184 €
TP409	90	87,5 - 89	195 €

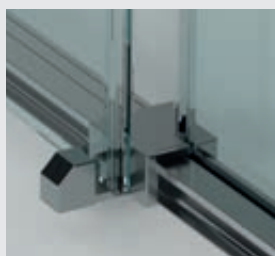

Detalle Guiador inferior

PLAZO DE EXPEDICIONES

- Transparentes 48 horas

TREBOL

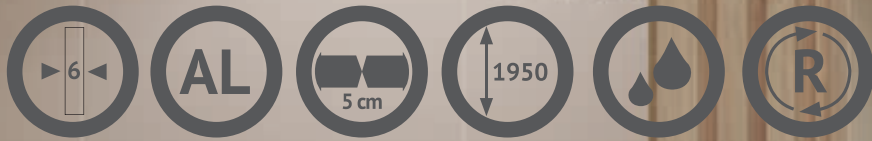





Detalle Conexión. Cristal Fijo Lateral 400.



TREBOL

Modelo **TREBOL 400**. Mampara Angular Corredera. Entrada Frontal **3 hojas**.

MAMPARA DE BAÑO SERIE TREBOL 100

BATHROOM SCREEN TREBOL 100 SERIES | ÉCRAN DE SALLE DE BAIN SÉRIE TREBOL 100



MAMPARA ESTANDAR

CÓDIGO	MEDIDA	RANGO DE INSTALACIÓN	TRANSPARENTE	DECORADO		APERTURA
				GRUPO I	GRUPO II	
TR1090	90	85-90	420 €	533 €	578 €	42-47
TR1095	95	90-95	429 €	541 €	586 €	45-50
TR1100	100	95-100	434 €	546 €	591 €	49-54
TR1105	105	100-105	441 €	553 €	598 €	52-57
TR1110	110	105-110	449 €	561 €	606 €	55-60
TR1115	115	110-115	458 €	570 €	615 €	59-60
TR1120	120	115-120	465 €	577 €	622 €	62-67
TR1125	125	120-125	473 €	585 €	630 €	65-70
TR1130	130	125-130	480 €	593 €	638 €	69-74
TR1135	135	130-135	489 €	601 €	646 €	72-77
TR1140	140	135-140	497 €	609 €	654 €	75-80

ESPECIALES A MEDIDA

CÓDIGO	MEDIDA	TRANSPARENTE	DECORADO	
			GRUPO I	GRUPO II
TRS1090	HASTA 90	491 €	567 €	675 €
TRS1120	HASTA 120	539 €	630 €	728 €
TRS1140	HASTA 140	570 €	683 €	780 €
TRS1160	HASTA 160	602 €	735 €	825 €
TRS1180	HASTA 180	634 €	781 €	871 €



DIMENSIONES MÁXIMAS MAMPARAS A MEDIDA

- Altura máxima 2200 mm
- Ancho máximo 1800 mm

ESPECIFICACIONES TRAMITACIÓN PEDIDOS

- Indicar medida de hueco real para adaptar la mejor opción y evitar errores de códigos
- Indicar posición de puerta mirando la mampara desde fuera (mano)
- Especificar cuando el plato este enrasado a suelo o sea de obra.

PLAZO DE EXPEDICIONES

- Transparentes 48 horas
- Decorados 5 días hábiles GRUPO 1 (EXCEPTO MATE Y PARSOLES)
- Cristales especiales y decorados (GRUPO 2, MATE Y PARSOLES) 15 días

MAMPARA DE BAÑO SERIE TREBOL 400

BATHROOM SCREEN TREBOL 400 SERIES | ÉCRAN DE SALLE DE BAIN SÉRIE TREBOL 400



MAMPARA ESTANDAR

CÓDIGO	MEDIDA	RANGO DE INSTALACIÓN	TRANSPARENTE	DECORADO		APERTURA
				GRUPO I	GRUPO II	
TR4097	90x70	85-95 / 67-69,5	656 €	829 €	919 €	42-47
TR4098	90x80	85-95 / 77-79,5	668 €	850 €	940 €	42-47
TR4099	90x90	85-95 / 87-89,5	692 €	883 €	973 €	42-47
TR4107	100x70	95-105 / 67-69,5	668 €	837 €	927 €	49-54
TR4108	100x80	95-105 / 77-79,5	680 €	859 €	949 €	49-54
TR4109	100x90	95-105 / 87-89,5	704 €	892 €	982 €	49-54
TR4117	110x70	105-115 / 67-69,5	685 €	842 €	932 €	55-60
TR4118	110x80	105-115 / 77-79,5	697 €	863 €	953 €	55-60
TR4119	110x90	105-115 / 87-89,5	721 €	896 €	986 €	55-60
TR4127	120x70	115-125 / 67-69,5	700 €	850 €	940 €	62-67
TR4128	120x80	115-125 / 77-79,5	712 €	871 €	961 €	62-67
TR4129	120x90	115-125 / 87-89,5	736 €	904 €	994 €	62-67
TR4137	130x70	125-135 / 67-69,5	716 €	858 €	948 €	69-74
TR4138	130x80	125-135 / 77-79,5	728 €	879 €	969 €	69-74
TR4139	130x90	125-135 / 87-89,5	752 €	912 €	1.002 €	69-74
TR4147	140x70	135-140 / 67-69,5	724 €	866 €	986 €	75-80
TR4148	140x80	135-140 / 77-79,5	736 €	887 €	1.007 €	75-80
TR4149	140x90	135-140 / 87-89,5	760 €	920 €	1.040 €	75-80

ESPECIALES A MEDIDA

CÓDIGO	MEDIDA	TRANSPARENTE	DECORADO	
			GRUPO I	GRUPO II
TRS4050	HASTA 50	276 €	325 €	370 €
TRS4070	HASTA 70	308 €	368 €	413 €
TRS4090	HASTA 90	341 €	420 €	465 €
TRS4110	HASTA 110	373 €	463 €	508 €

SÓLO LATERAL

CÓDIGO	MEDIDA	RANGO DE INSTALACIÓN	TRANSPARENTE	DECORADO	
				GRUPO I	GRUPO II
TR407	70	67,5-69,5	248 €	308 €	353 €
TR408	80	77,5-79,5	271 €	339 €	384 €
TR409	90	87,5-89,5	284 €	364 €	409 €

TREBOL

MAMPARA DE BAÑO SERIE TREBOL 800

BATHROOM SCREEN TREBOL 800 SERIES | ÉCRAN DE SALLE DE BAIN SÉRIE TREBOL 800

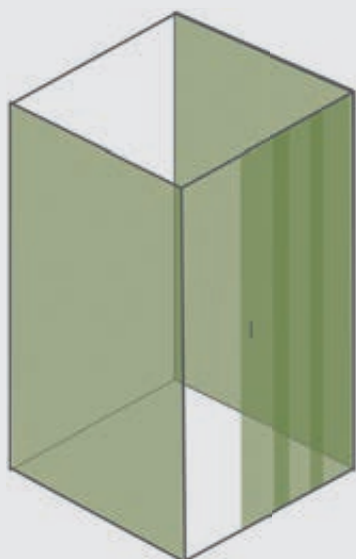

ESPECIALES A MEDIDA SÓLO LATERAL

CÓDIGO	MEDIDA	TRANSPARENTE	DECORADO	
			GRUPO I	GRUPO II
TRS8050	HASTA 50	326 €	402 €	447 €
TRS8070	HASTA 70	340 €	428 €	473 €
TRS8090	HASTA 90	355 €	453 €	498 €
TRS8110	HASTA 110	368 €	468 €	513 €

TRENTO

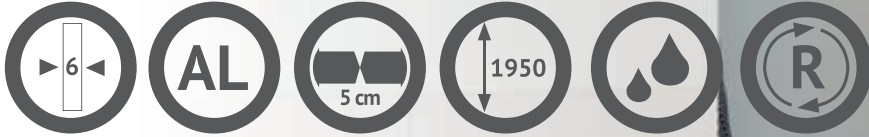



MAMPARA DE BAÑO SERIE TRENTO100

BATHROOM SCREEN TRENTO 100 SERIES | ÉCRAN DE SALLE DE BAIN SÉRIE TRENTO 100

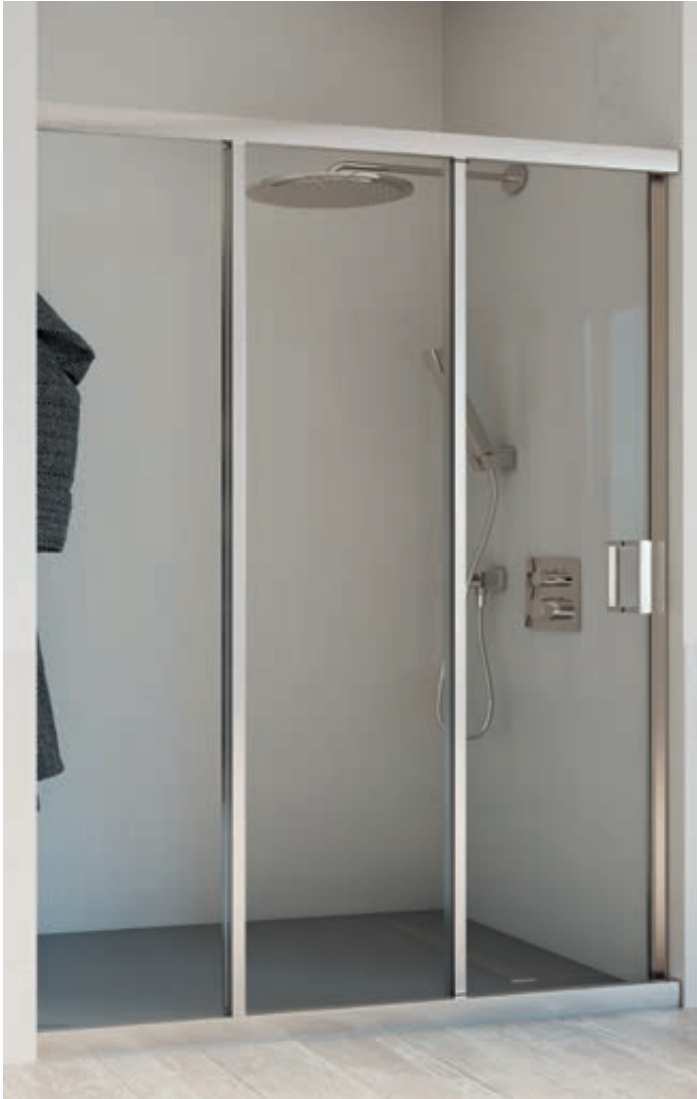

MAMPARA ESTANDAR

CÓDIGO	MEDIDA	RANGO DE INSTALACIÓN	TRANSPARENTE	APERTURA
TT1090	90	86-90	340 €	48
TT1095	95	91-95	347 €	51
TT1100	100	96-100	353 €	54
TT1105	105	101-105	361 €	58
TT1110	110	106-110	369 €	61
TT1115	115	111-115	376 €	64
TT1120	120	116-120	384 €	68
TT1125	125	121-125	393 €	71
TT1130	130	126-130	400 €	74
TT1135	135	131-135	408 €	78
TT1140	140	136-140	417 €	81



MAMPARA DE BAÑO SERIE TRENTO 400

BATHROOM SCREEN TRENTO 400 SERIES | ÉCRAN DE SALLE DE BAIN SÉRIE TRENTO 400



MAMPARA ESTANDAR

CÓDIGO	MEDIDA	RANGO DE INSTALACIÓN	TRANSPARENTE
TT4097	90x70	86,6-88,6 / 67,5-69,5	548 €
TT4098	90x80	86,6-88,6 / 77,5-79,5	570 €
TT4099	90x90	86,6-88,6 / 87,5-89,5	584 €
TT4107	100x70	95-105 / 67-69,5	561 €
TT4108	100x80	95-105 / 77-79,5	583 €
TT4109	100x90	95-105 / 87-89,5	597 €
TT4117	110x70	105-115 / 67-69,5	577 €
TT4118	110x80	105-115 / 77-79,5	599 €
TT4119	110x90	105-115 / 87-89,5	613 €
TT4127	120x70	115-125 / 67-69,5	592 €
TT4128	120x80	115-125 / 77-79,5	614 €
TT4129	120x90	115-125 / 87-89,5	628 €
TT4137	130x70	125-135 / 67-69,5	608 €
TT4138	130x80	125-135 / 77-79,5	630 €
TT4139	130x90	125-135 / 87-89,5	644 €
TT4147	140x70	135-140 / 67-69,5	625 €
TT4148	140x80	135-140 / 77-79,5	647 €
TT4149	140x90	135-140 / 87-89,5	661 €

SÓLO LATERAL

CÓDIGO	MEDIDA	RANGO DE INSTALACIÓN	TRANSPARENTE
TT407	70	67,5-69,5	208 €
TT408	80	77,5-79,5	230 €
TT409	90	87,5-89,5	244 €

TRENTO

PLAZO DE EXPEDICIONES
 • Transparentes 48 horas



DOUBLE







Modelo **DOUBLE 400**. Mampara Angular Corredera. **DOBLE** Entrada Frontal.

DIMENSIONES MÁXIMAS MAMPARAS A MEDIDA

- Altura máxima 1950 mm
- Ancho máximo 1700 mm

ESPECIFICACIONES TRAMITACIÓN PEDIDOS

- Indicar medida de hueco real para adaptar la mejor opción y evitar errores de códigos
- Indicar posición de puerta mirando la mampara desde fuera (mano)
- Especificar cuando el plato este enrasado a suelo o sea de obra.

PLAZO DE EXPEDICIONES

- Plazo de expedición en todas sus modalidades 15 días.
- Cristales especiales y decorados (GRUPO 2, MATE Y PARSOLES) 15 días

MAMPARA DE BAÑO SERIE DOUBLE 100

BATHROOM SCREEN DOUBLE 100 SERIES | ÉCRAN DE SALLE DE BAIN SÉRIE DOUBLE 100



MAMPARA ESTANDAR

CÓDIGO	MEDIDA	RANGO DE INSTALACIÓN	TRANSPARENTE	DECORADO		APERTURA
				GRUPO I	GRUPO II	
DB1100	100	95-100	505 €	578 €	623 €	40-45
DB1105	105	100-105	512 €	584 €	629 €	42,5-47,5
DB1110	110	105-110	518 €	591 €	636 €	45-50
DB1115	115	110-115	527 €	600 €	645 €	47,5-52,5
DB1120	120	115-120	534 €	606 €	651 €	50-55
DB1125	125	120-125	541 €	614 €	659 €	52,5-57,5
DB1130	130	125-130	549 €	622 €	667 €	55-60
DB1135	135	130-135	556 €	628 €	673 €	57,5-62,5
DB1140	140	135-140	564 €	637 €	682 €	60-65
DB1145	145	140-145	580 €	685 €	775 €	62,5-67,5
DB1150	150	145-150	587 €	696 €	786 €	65-70
DB1155	155	150-155	594 €	706 €	796 €	67,5-72,5
DB1160	160	155-160	603 €	719 €	809 €	70-75

ESPECIALES

CÓDIGO	MEDIDA	TRANSPARENTE	DECORADO	
			GRUPO I	GRUPO II
DBS1120	HASTA120	694 €	767 €	812 €
DBS1140	HASTA140	734 €	806 €	851 €
DBS1160	HASTA160	783 €	900 €	945 €

MAMPARA DE BAÑO SERIE DOUBLE 400

BATHROOM SCREEN DOUBLE 400 SERIES | ÉCRAN DE SALLE DE BAIN SÉRIE DOUBLE 400



MAMPARA ESTANDAR

CÓDIGO	MEDIDA	RANGO DE INSTALACIÓN	TRANSPARENTE	DECORADO		APERTURA
				GRUPO I	GRUPO II	
DB4107	100x70	95-100/67-69,5	648 €	813 €	903 €	40-45
DB4108	100x80	95-100 / 77-79,5	660 €	834 €	924 €	40-45
DB4109	100x90	95-100 / 87-89,5	683 €	866 €	956 €	40-45
DB4117	110x70	105-110 / 67-69,5	664 €	817 €	907 €	45-50
DB4118	110x80	105-110 / 77-79,5	677 €	838 €	928 €	45-50
DB4119	110x90	105-110 / 87-89,5	700 €	870 €	960 €	45-50
DB4127	120x70	115-120 / 67-69,5	680 €	825 €	915 €	50-55
DB4128	120x80	115-120 / 77-79,5	692 €	845 €	935 €	50-55
DB4129	120x90	115-125 / 87-89,5	715 €	878 €	968 €	50-55
DB4137	130x70	125-135 / 67-69,5	695 €	833 €	923 €	55-60
DB4138	130x80	125-135 / 77-79,5	706 €	854 €	944 €	55-60
DB4139	130x90	125-135 / 87-89,5	730 €	886 €	976 €	55-60
DB4147	140x70	135-140 / 67-69,5	703 €	842 €	932 €	60-65
DB4148	140x80	135-140 / 77-79,5	715 €	861 €	951 €	60-65
DB4149	140x90	135-140 / 87-89,5	738 €	893 €	983 €	60-65

SÓLO LATERAL ESTANDAR

CÓDIGO	MEDIDA	RANGO DE INSTALACIÓN	TRANSPARENTE	DECORADO	
				GRUPO I	GRUPO II
DB407	70	67,5-69,5	241 €	299 €	344 €
DB408	80	77,5-79,5	263 €	329 €	374 €
DB409	90	87,5-89,5	276 €	353 €	398 €

ESPECIALES

CÓDIGO	MEDIDA	TRANSPARENTE	DECORADO	
			GRUPO I	GRUPO II
DBS4050	HASTA50	224 €	261 €	306 €
DBS4050	HASTA70	255 €	312 €	357 €
DBS4090	HASTA90	287 €	363 €	408 €
DBS4110	HASTA110	318 €	414 €	459 €

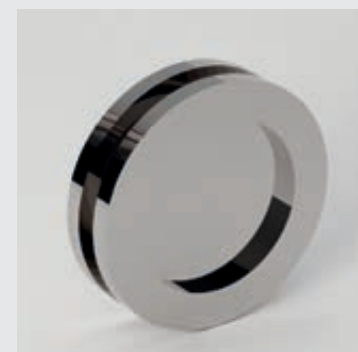



TEDY

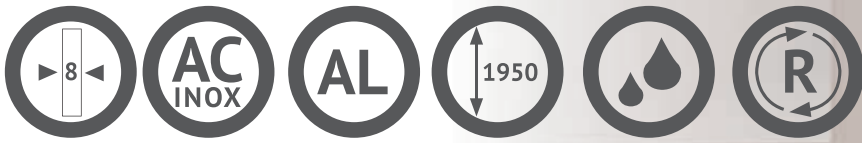









Modelo **TEDY TRIPLE Z**. Mampara **Abatible**. **DOBLE** Entrada Frontal. Separador de Estancias. Perfilera **NEGRA**.



Detalle Tiranta de seguridad opcional Modelo **TEDY TRIPLE Z**. Color perfilería **NEGRA**.



Modelo **TEDY TRIPLE Z**. Mampara **Abatible**. **DOBLE** Entrada Frontal. Separador de Estancias. Perfilería **NEGRA**.



Modelo **TEDY TRIPLE Z**. Mampara **Abatible**. **DOBLE** Entrada Frontal. Separador de Estancias. Perfilería **NEGRA**. Cristales decorados **PARSOL FUME**.

MAMPARA DE BAÑO SERIE TEDY P00

BATHROOM SCREEN TEDY P00 SERIES | ÉCRAN DE SALLE DE BAIN SÉRIE TEDY P00







MAMPARA ESTANDAR

CODIGO	MEDIDA	TRANSPARENTE	DECORADO	
			GRUPO I	GRUPO II
TDP050	HASTA 50	363 €	418 €	463 €
TDP070	HASTA 70	390 €	452 €	497 €
TDP080	HASTA 80	403 €	482 €	527 €
TDP090	HASTA 90	417 €	512 €	557 €

ESPECIALES A MEDIDA

CODIGO	MEDIDA	TRANSPARENTE	DECORADO	
			GRUPO I	GRUPO II
TDSP050	HASTA 50	435 €	502 €	547 €
TDSP070	HASTA 70	468 €	542 €	587 €
TDSP080	HASTA 80	484 €	578 €	623 €
TDSP090	HASTA 90	500 €	615 €	660 €

INCREMENTO PERFILERÍA COLORES

NEGRO  + 45€ ORO MATE  + 150€ ORO BRILLO  + 150€ ORO ROSA  + 150€

MAMPARA DE BAÑO SERIE TEDY 100A

BATHROOM SCREEN TEDY 100A SERIES | ÉCRAN DE SALLE DE BAIN SÉRIE TEDY 100A







MAMPARA ESTANDAR

CÓDIGO	MEDIDA	TRANSPARENTE	DECORADO	
			GRUPO I	GRUPO II
TD1070A	HASTA 70	472 €	563 €	608 €
TD1090A	HASTA 90	500 €	597 €	642 €
TD1120A	HASTA 120	542 €	659 €	704 €
TD1140A	HASTA 140	569 €	693 €	738 €
TD1160A	HASTA 160	597 €	753 €	843 €
TD1180A	HASTA 180	624 €	813 €	903 €
TD1200A	HASTA 200	651 €	858 €	948 €

ESPECIALES A MEDIDA

CÓDIGO	MEDIDA	TRANSPARENTE	DECORADO	
			GRUPO I	GRUPO II
TDS1070A	HASTA 70	567 €	676 €	721 €
TDS1090A	HASTA 90	600 €	717 €	762 €
TDS1120A	HASTA 120	650 €	791 €	836 €
TDS1140A	HASTA 140	683 €	832 €	922 €
TDS1160A	HASTA 160	717 €	904 €	994 €
TDS1180A	HASTA 180	749 €	976 €	1.066 €
TDS1200A	HASTA 200	782 €	1.029 €	1.119 €

INCREMENTO PERFILERÍA COLORES

NEGRO  + 45€ ORO MATE  + 150€ ORO BRILLO  + 150€ ORO ROSA  + 150€

MAMPARA DE BAÑO SERIE TEDY 100B

BATHROOM SCREEN TEDY 100B SERIES | ÉCRAN DE SALLE DE BAIN SÉRIE TEDY 100B







MAMPARA ESTANDAR

CÓDIGO	MEDIDA	TRANSPARENTE	DECORADO	
			GRUPO I	GRUPO II
TD1070B	HASTA 70	495 €	586 €	631 €
TD1090B	HASTA 90	522 €	650 €	695 €
TD1120B	HASTA 120	564 €	708 €	753 €
TD1140B	HASTA 140	591 €	742 €	787 €
TD1160B	HASTA 160	639 €	776 €	866 €
TD1180B	HASTA 180	647 €	845 €	935 €
TD1200B	HASTA 200	674 €	880 €	970 €

ESPECIALES A MEDIDA

CÓDIGO	MEDIDA	TRANSPARENTE	DECORADO	
			GRUPO I	GRUPO II
TDS1070B	HASTA 70	594 €	703 €	748 €
TDS1090B	HASTA 90	627 €	780 €	825 €
TDS1120B	HASTA 120	677 €	850 €	895 €
TDS1140B	HASTA 140	710 €	891 €	936 €
TDS1160B	HASTA 160	767 €	931 €	1.021 €
TDS1180B	HASTA 180	776 €	1.014 €	1.104 €
TDS1200B	HASTA 200	809 €	1.056 €	1.146 €

INCREMENTO PERFILERÍA COLORES

NEGRO  + 45€ ORO MATE  + 150€ ORO BRILLO  + 150€ ORO ROSA  + 150€

MAMPARA DE BAÑO SERIE TEDY 200A

BATHROOM SCREEN TEDY 200A SERIES | ÉCRAN DE SALLE DE BAIN SÉRIE TEDY 200A



MAMPARA ESTANDAR

CÓDIGO	MEDIDA	TRANSPARENTE	DECORADO	
			GRUPO I	GRUPO II
TD2080A	HASTA 80	560 €	642 €	687 €
TD2100A	HASTA 100	588 €	699 €	744 €
TD2120A	HASTA 120	615 €	733 €	778 €
TD2140A	HASTA 140	642 €	767 €	812 €
TD2160A	HASTA 160	671 €	827 €	917 €
TD2180A	HASTA 180	698 €	861 €	951 €

ESPECIALES A MEDIDA

CÓDIGO	MEDIDA	TRANSPARENTE	DECORADO	
			GRUPO I	GRUPO II
TDS2080A	HASTA 80	672 €	771 €	816 €
TDS2100A	HASTA 100	706 €	839 €	884 €
TDS2120A	HASTA 120	738 €	880 €	925 €
TDS2140A	HASTA 140	771 €	920 €	965 €
TDS2160A	HASTA 160	805 €	993 €	1.083 €
TDS2180A	HASTA 180	838 €	1.033 €	1.123 €

INCREMENTO PERFILERÍA COLORES

NEGRO + 65€ ORO MATE + 200€ ORO BRILLO + 200€ ORO ROSA + 200€

MAMPARA DE BAÑO SERIE TEDY 200B

BATHROOM SCREEN TEDY 200B SERIES | ÉCRAN DE SALLE DE BAIN SÉRIE TEDY 200B



MAMPARA ESTANDAR

CÓDIGO	MEDIDA	TRANSPARENTE	DECORADO	
			GRUPO I	GRUPO II
TD2100B	HASTA 100	746 €	891 €	936 €
TD2120B	HASTA 120	774 €	925 €	970 €
TD2140B	HASTA 140	801 €	959 €	1.004 €
TD2160B	HASTA 160	828 €	1.015 €	1.105 €
TD2180B	HASTA 180	857 €	1.049 €	1.139 €
TD2200B	HASTA 200	884 €	1.106 €	1.196 €
TD2220B	HASTA 220	911 €	1.140 €	1.230 €
TD2240B	HASTA 240	938 €	1.174 €	1.264 €

ESPECIALES A MEDIDA

CÓDIGO	MEDIDA	TRANSPARENTE	DECORADO	
			GRUPO I	GRUPO II
TDS2100B	HASTA 100	895 €	1.069 €	1.114 €
TDS2120B	HASTA 120	929 €	1.109 €	1.154 €
TDS2140B	HASTA 140	961 €	1.150 €	1.195 €
TDS2160B	HASTA 160	994 €	1.218 €	1.308 €
TDS2180B	HASTA 180	1.028 €	1.259 €	1.349 €
TDS2200B	HASTA 200	1.060 €	1.327 €	1.417 €
TDS2220B	HASTA 220	1.093 €	1.368 €	1.458 €
TDS2240B	HASTA 240	1.126 €	1.409 €	1.499 €

INCREMENTO PERFILERÍA COLORES

NEGRO + 65€ ORO MATE + 200€ ORO BRILLO + 200€ ORO ROSA + 200€

MAMPARA DE BAÑO SERIE TEDY 200AB

BATHROOM SCREEN TEDY 200AB SERIES | ÉCRAN DE SALLE DE BAIN SÉRIE TEDY 200AB



MAMPARA ESTANDAR

CÓDIGO	MEDIDA	TRANSPARENTE	DECORADO	
			GRUPO I	GRUPO II
TD2100AB	HASTA 100	640 €	757 €	802 €
TD2120AB	HASTA 120	668 €	813 €	858 €
TD2140AB	HASTA 140	696 €	847 €	892 €
TD2160AB	HASTA 160	723 €	893 €	938 €
TD2180AB	HASTA 180	751 €	927 €	972 €
TD2200AB	HASTA 200	778 €	994 €	1.039 €
TD2220AB	HASTA 220	806 €	1.028 €	1.073 €

ESPECIALES A MEDIDA

CÓDIGO	MEDIDA	TRANSPARENTE	DECORADO	
			GRUPO I	GRUPO II
TDS2100AB	HASTA 100	768 €	908 €	953 €
TDS2120AB	HASTA 120	802 €	976 €	1.021 €
TDS2140AB	HASTA 140	835 €	1.017 €	1.062 €
TDS2160AB	HASTA 160	867 €	1.071 €	1.161 €
TDS2180AB	HASTA 180	901 €	1.112 €	1.202 €
TDS2200AB	HASTA 200	934 €	1.192 €	1.282 €
TDS2220AB	HASTA 220	967 €	1.233 €	1.323 €

INCREMENTO PERFILERÍA COLORES

NEGRO + 65€ ORO MATE + 200€ ORO BRILLO + 200€ ORO ROSA + 200€

MAMPARA DE BAÑO SERIE TEDY 200AC

BATHROOM SCREEN TEDY 200AC SERIES | ÉCRAN DE SALLE DE BAIN SÉRIE TEDY 200AC







MAMPARA ESTANDAR

CÓDIGO	MEDIDA A+B	TRANSPARENTE	DECORADO	
			GRUPO I	GRUPO II
TD2120AC	HASTA 120	668 €	813 €	858 €
TD2140AC	HASTA 140	696 €	847 €	892 €
TD2160AC	HASTA 160	723 €	893 €	983 €
TD2180AC	HASTA 180	751 €	927 €	1.017 €
TD2200AC	HASTA 200	778 €	994 €	1.084 €
TD2220AC	HASTA 220	806 €	1.028 €	1.118 €

ESPECIALES A MEDIDA

CÓDIGO	MEDIDA A+B	TRANSPARENTE	DECORADO	
			GRUPO I	GRUPO II
TDS2120AC	HASTA 120	802 €	976 €	1.021 €
TDS2140AC	HASTA 140	835 €	1.017 €	1.062 €
TDS2160AC	HASTA 160	867 €	1.071 €	1.161 €
TDS2180AC	HASTA 180	901 €	1.112 €	1.202 €
TDS2200AC	HASTA 200	934 €	1.192 €	1.282 €
TDS2220AC	HASTA 220	967 €	1.233 €	1.323 €

INCREMENTO PERFILERÍA COLORES

 NEGRO  + 65€ ORO MATE  + 200€ ORO BRILLO  + 200€ ORO ROSA  +200€
MAMPARA DE BAÑO SERIE TEDY 300A

BATHROOM SCREEN TEDY 300A SERIES | ÉCRAN DE SALLE DE BAIN SÉRIE TEDY 300A







MAMPARA ESTANDAR

CÓDIGO	MEDIDA A+B	TRANSPARENTE	DECORADO	
			GRUPO I	GRUPO II
TD3100A	HASTA 100	535 €	646 €	691 €
TD3120A	HASTA 120	563 €	680 €	725 €
TD3140A	HASTA 140	590 €	715 €	760 €
TD3160A	HASTA 160	617 €	775 €	865 €
TD3180A	HASTA 180	646 €	809 €	899 €

ESPECIALES A MEDIDA

CÓDIGO	MEDIDA A+B	TRANSPARENTE	DECORADO	
			GRUPO I	GRUPO II
TDS3100A	HASTA 100	642 €	775 €	820 €
TDS3120A	HASTA 120	676 €	816 €	861 €
TDS3140A	HASTA 140	708 €	858 €	903 €
TDS3160A	HASTA 160	741 €	930 €	1.020 €
TDS3180A	HASTA 180	775 €	971 €	1.061 €

INCREMENTO PERFILERÍA COLORES

 NEGRO  + 65€ ORO MATE  + 200€ ORO BRILLO  + 200€ ORO ROSA  +200€
MAMPARA DE BAÑO SERIE TEDY 300B

BATHROOM SCREEN TEDY 300B SERIES | ÉCRAN DE SALLE DE BAIN SÉRIE TEDY 300B







MAMPARA ESTANDAR

CÓDIGO	MEDIDA A+B	TRANSPARENTE	DECORADO	
			GRUPO I	GRUPO II
TD3120B	HASTA 120	774 €	925 €	970 €
TD3140B	HASTA 140	801 €	959 €	1.004 €
TD3160B	HASTA 160	828 €	993 €	1.083 €
TD3180B	HASTA 180	857 €	1.049 €	1.139 €
TD3200B	HASTA 200	884 €	1.083 €	1.173 €
TD3220B	HASTA 220	911 €	1.140 €	1.230 €

ESPECIALES A MEDIDA

CÓDIGO	MEDIDA A+B	TRANSPARENTE	DECORADO	
			GRUPO I	GRUPO II
TDS3120B	HASTA 120	929 €	1.109 €	1.154 €
TDS3140B	HASTA 140	961 €	1.150 €	1.195 €
TDS3160B	HASTA 160	994 €	1.191 €	1.281 €
TDS3180B	HASTA 180	1.028 €	1.259 €	1.349 €
TDS3200B	HASTA 200	1.060 €	1.300 €	1.390 €
TDS3220B	HASTA 220	1.093 €	1.368 €	1.458 €

INCREMENTO PERFILERÍA COLORES

 NEGRO  + 65€ ORO MATE  + 200€ ORO BRILLO  + 200€ ORO ROSA  +200€

MAMPARA DE BAÑO SERIE TEDY 300AB

BATHROOM SCREEN TEDY 300AB SERIES | ÉCRAN DE SALLE DE BAIN SÉRIE TEDY 300AB

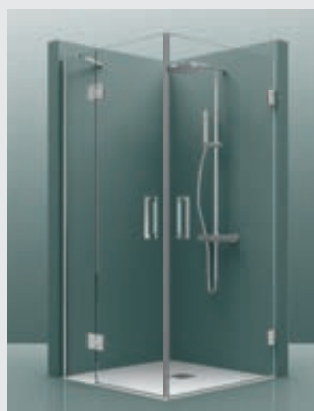

MAMPARA ESTANDAR

CÓDIGO	MEDIDA A+B	TRANSPARENTE	DECORADO	
			GRUPO I	GRUPO II
TD3100AB	HASTA 100	640 €	757 €	802 €
TD3120AB	HASTA 120	668 €	813 €	858 €
TD3140AB	HASTA 140	696 €	847 €	892 €
TD3160AB	HASTA 160	723 €	893 €	983 €
TD3180AB	HASTA 180	751 €	927 €	1.017 €
TD3200AB	HASTA 200	778 €	994 €	1.084 €
TD3220AB	HASTA 220	806 €	1.028 €	1.118 €

ESPECIALES A MEDIDA

CÓDIGO	MEDIDA A+B	TRANSPARENTE	DECORADO	
			GRUPO I	GRUPO II
TDS3100AB	HASTA 100	768 €	908 €	953 €
TDS3120AB	HASTA 120	802 €	976 €	1.021 €
TDS3140AB	HASTA 140	835 €	1.017 €	1.062 €
TDS3160AB	HASTA 160	867 €	1.071 €	1.161 €
TDS3180AB	HASTA 180	901 €	1.112 €	1.202 €
TDS3200AB	HASTA 200	934 €	1.192 €	1.282 €
TDS3220AB	HASTA 220	967 €	1.233 €	1.323 €

INCREMENTO PERFILERÍA COLORES

NEGRO + 65€ ORO MATE + 200€ ORO BRILLO + 200€ ORO ROSA +200€

MAMPARA DE BAÑO SERIE TEDY 400A

BATHROOM SCREEN TEDY 400A SERIES | ÉCRAN DE SALLE DE BAIN SÉRIE TEDY 400A



MAMPARA ESTANDAR

CÓDIGO	MEDIDA A+B	TRANSPARENTE	DECORADO	
			GRUPO I	GRUPO II
TD4100A	HASTA 100	487 €	588 €	633 €
TD4120A	HASTA 120	516 €	632 €	677 €
TD4140A	HASTA 140	563 €	657 €	702 €
TD4160A	HASTA 160	570 €	727 €	817 €
TD4180A	HASTA 180	598 €	776 €	866 €
TD4200A	HASTA 200	625 €	830 €	920 €
TD4220A	HASTA 220	653 €	864 €	954 €

ESPECIALES A MEDIDA

CÓDIGO	MEDIDA A+B	TRANSPARENTE	DECORADO	
			GRUPO I	GRUPO II
TDS4100A	HASTA 100	585 €	706 €	751 €
TDS4120A	HASTA 120	619 €	759 €	804 €
TDS4140A	HASTA 140	676 €	789 €	834 €
TDS4160A	HASTA 160	684 €	873 €	963 €
TDS4180A	HASTA 180	718 €	931 €	1.021 €
TDS4200A	HASTA 200	750 €	997 €	1.087 €
TDS4220A	HASTA 220	783 €	1.037 €	1.127 €

INCREMENTO PERFILERÍA COLORES

NEGRO + 65€ ORO MATE + 200€ ORO BRILLO + 200€ ORO ROSA +200€

MAMPARA DE BAÑO SERIE TEDY 400B

BATHROOM SCREEN TEDY 400B SERIES | ÉCRAN DE SALLE DE BAIN SÉRIE TEDY 400B

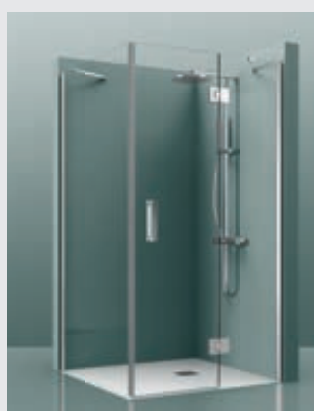

MAMPARA ESTANDAR

CÓDIGO	MEDIDA A+B	TRANSPARENTE	DECORADO	
			GRUPO I	GRUPO II
TD4100B	HASTA 100	593 €	709 €	754 €
TD4120B	HASTA 120	621 €	766 €	811 €
TD4140B	HASTA 140	648 €	800 €	845 €
TD4160B	HASTA 160	675 €	845 €	935 €
TD4180B	HASTA 180	704 €	879 €	969 €
TD4200B	HASTA 200	731 €	946 €	1.036 €
TD4220B	HASTA 220	758 €	980 €	1.070 €

ESPECIALES A MEDIDA

CÓDIGO	MEDIDA A+B	TRANSPARENTE	DECORADO	
			GRUPO I	GRUPO II
TDS4100B	HASTA 100	711 €	851 €	896 €
TDS4120B	HASTA 120	745 €	919 €	964 €
TDS4140B	HASTA 140	778 €	960 €	1.005 €
TDS4160B	HASTA 160	810 €	1.014 €	1.104 €
TDS4180B	HASTA 180	844 €	1.055 €	1.145 €
TDS4200B	HASTA 200	877 €	1.135 €	1.225 €
TDS4220B	HASTA 220	910 €	1.176 €	1.266 €

INCREMENTO PERFILERÍA COLORES

NEGRO + 65€ ORO MATE + 200€ ORO BRILLO + 200€ ORO ROSA +200€

MAMPARA DE BAÑO SERIE TEDY 400C

BATHROOM SCREEN TEDY 400C SERIES | ÉCRAN DE SALLE DE BAIN SÉRIE TEDY 400C







MAMPARA ESTANDAR

CÓDIGO	MEDIDA A+B	TRANSPARENTE	DECORADO	
			GRUPO I	GRUPO II
TD4100C	HASTA 100	521 €	622 €	667 €
TD4120C	HASTA 120	550 €	666 €	711 €
TD4140C	HASTA 140	597 €	691 €	736 €
TD4160C	HASTA 160	604 €	761 €	851 €
TD4180C	HASTA 180	632 €	810 €	900 €
TD4200C	HASTA 200	659 €	864 €	954 €
TD4220C	HASTA 220	687 €	898 €	988 €

ESPECIALES A MEDIDA

CÓDIGO	MEDIDA A+B	TRANSPARENTE	DECORADO	
			GRUPO I	GRUPO II
TDS4100C	HASTA 100	625 €	746 €	791 €
TDS4120C	HASTA 120	659 €	799 €	844 €
TDS4140C	HASTA 140	717 €	829 €	874 €
TDS4160C	HASTA 160	725 €	914 €	1.004 €
TDS4180C	HASTA 180	759 €	972 €	1.062 €
TDS4200C	HASTA 200	791 €	1.037 €	1.127 €
TDS4220C	HASTA 220	824 €	1.078 €	1.168 €

INCREMENTO PERFILERÍA COLORES

 NEGRO  + 65€ ORO MATE  + 200€ ORO BRILLO  + 200€ ORO ROSA  +200€
MAMPARA DE BAÑO SERIE TEDY 400BC

BATHROOM SCREEN TEDY 400BC SERIES | ÉCRAN DE SALLE DE BAIN SÉRIE TEDY 400BC







MAMPARA ESTANDAR

CÓDIGO	MEDIDA A+B	TRANSPARENTE	DECORADO	
			GRUPO I	GRUPO II
TD4120BC	HASTA 120	655 €	800 €	845 €
TD4140BC	HASTA 140	682 €	834 €	879 €
TD4160BC	HASTA 160	709 €	879 €	969 €
TD4180BC	HASTA 180	738 €	913 €	1.003 €
TD4200BC	HASTA 200	765 €	980 €	1.070 €
TD4220BC	HASTA 220	792 €	1.014 €	1.104 €

ESPECIALES A MEDIDA

CÓDIGO	MEDIDA A+B	TRANSPARENTE	DECORADO	
			GRUPO I	GRUPO II
TDS4120BC	HASTA 120	711 €	960 €	1.005 €
TDS4140BC	HASTA 140	745 €	1.001 €	1.046 €
TDS4160BC	HASTA 160	778 €	1.055 €	1.145 €
TDS4180BC	HASTA 180	810 €	1.096 €	1.186 €
TDS4200BC	HASTA 200	844 €	1.176 €	1.266 €
TDS4220BC	HASTA 220	877 €	1.217 €	1.307 €

INCREMENTO PERFILERÍA COLORES

 NEGRO  + 65€ ORO MATE  + 200€ ORO BRILLO  + 200€ ORO ROSA  +200€
MAMPARA DE BAÑO SERIE TEDY 900

BATHROOM SCREEN TEDY 900 SERIES | ÉCRAN DE SALLE DE BAIN SÉRIE TEDY 900







MAMPARA ESTANDAR

CÓDIGO	MEDIDA	TRANSPARENTE	DECORADO	
			GRUPO I	GRUPO II
TD9100	HASTA 100	593 €	709 €	754 €
TD9120	HASTA 120	621 €	766 €	811 €
TD9140	HASTA 140	648 €	800 €	845 €
TD9160	HASTA 160	675 €	845 €	935 €
TD9180	HASTA 180	704 €	879 €	969 €
TD9200	HASTA 200	731 €	946 €	1.036 €
TD9220	HASTA 220	758 €	980 €	1.070 €

ESPECIALES A MEDIDA

CÓDIGO	MEDIDA	TRANSPARENTE	DECORADO	
			GRUPO I	GRUPO II
TDS9100	HASTA 100	711 €	851 €	896 €
TDS9120	HASTA 120	745 €	919 €	964 €
TDS9140	HASTA 140	778 €	960 €	1.005 €
TDS9160	HASTA 160	810 €	1.014 €	1.104 €
TDS9180	HASTA 180	844 €	1.055 €	1.145 €
TDS9200	HASTA 200	877 €	1.135 €	1.225 €
TDS9220	HASTA 220	910 €	1.176 €	1.266 €

INCREMENTO PERFILERÍA COLORES

 NEGRO  + 45€ ORO MATE  + 150€ ORO BRILLO  + 150€ ORO ROSA  +150€

MAMPARA DE BAÑO SERIE TEDY Z

BATHROOM SCREEN TEDY Z SERIES | ÉCRAN DE SALLE DE BAIN SÉRIE TEDY Z



MAMPARA ESTANDAR

CÓDIGO	MEDIDA	TRANSPARENTE	DECORADO	
			GRUPO I	GRUPO II
TDZ200	HASTA 200	979 €	1.160 €	1.250 €
TDZ250	HASTA 250	1.047 €	1.228 €	1.348 €
TDZ300	HASTA 300	1.115 €	1.296 €	1.456 €

ESPECIALES A MEDIDA



PUERTA
FIJO
PUERTA

CÓDIGO	MEDIDA	TRANSPARENTE	DECORADO	
			GRUPO I	GRUPO II
TDZS200	HASTA 200	988 €	1.160 €	1.250 €
TDZS250	HASTA 250	1.056 €	1.228 €	1.348 €
TDZS300	HASTA 300	1.125 €	1.296 €	1.456 €

ESPECIALES A MEDIDA



FIJO - PUERTA
FIJO
PUERTA - FIJO

CÓDIGO	MEDIDA	TRANSPARENTE	DECORADO	
			GRUPO I	GRUPO II
TDZS250B	HASTA 250	1.311 €	1.628 €	1.748 €
TDZS300B	HASTA 300	1.379 €	1.696 €	1.816 €
TDZS350B	HASTA 350	1.447 €	1.764 €	1.914 €
TDZS400B	HASTA 400	1.515 €	1.832 €	1.982 €

ESPECIALES A MEDIDA



PUERTA
FIJO
PUERTA - FIJO

CÓDIGO	MEDIDA	TRANSPARENTE	DECORADO	
			GRUPO I	GRUPO II
TDZS250AB	HASTA 250	1.403 €	1.795 €	1.915 €
TDZS300AB	HASTA 300	1.416 €	1.863 €	1.983 €
TDZS350AB	HASTA 350	1.450 €	1.931 €	2.081 €
TDZS400AB	HASTA 400	1.518 €	1.999 €	2.149 €

INCREMENTO PERFILERÍA COLORES

NEGRO + 100€ ORO MATE + 300€ ORO BRILLO + 300€ ORO ROSA + 300€



Bisagra **TEDY-A**



Bisagra **TEDY-B**

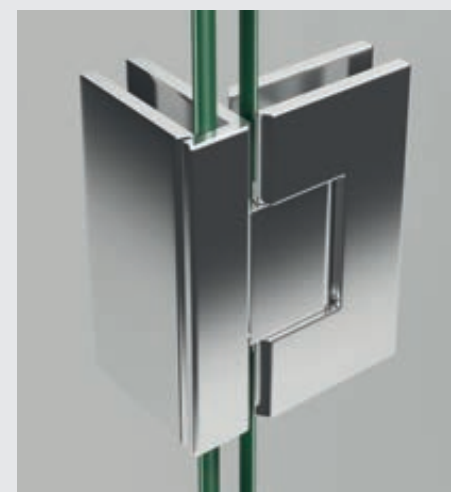

Bisagra **TEDY-C**

TENSORES OPCIONALES

- Plata 40 €, Negro 50 €, Resto de colores 70 €.

DIMENSIONES MÁXIMAS MAMPARAS A MEDIDA

- Altura máxima 2400 mm
- Ancho máximo DE PUERTA 900 mm

ESPECIFICACIONES TRAMITACIÓN PEDIDOS

- Indicar medida de hueco real para adaptar la mejor opción y evitar errores de códigos
- Indicar posición de puerta mirando la mampara desde fuera (mano)
- Especificar cuando el plato este enrasado a suelo o sea de obra.

PLAZO DE EXPEDICIONES

- Plazo de expedición en todas sus modalidades 15 días.
- Cristales especiales y decorados (GRUPO 2, MATE Y PARSOLES) 15 días



PADEL







Modelo **PADEL 800A**. Mampara **Abatible**. Entrada Frontal. Perfilera **NEGRA**.



Modelo **PADEL 100B**. Mampara **Abatible**. Entrada Frontal. Perifería **ORO BRILLO**.



Modelo **PADEL P00**. Adaptación **PMR**. Mampara **Abatible**. Entrada Segmentada Frontal. Incremento **+ 220 € PVP** sobre cualquier mampara serie **PADEL**.



Modelo **PADEL 900 ESPECIAL**. Mampara **Abatible**. Entrada Frontal. Perfilería **ORO MATE**.

MAMPARA DE BAÑO SERIE PADEL P00

BATHROOM SCREEN PADEL P00 SERIES | ÉCRAN DE SALLE DE BAIN SÉRIE PADEL P00

EXPEDICIONES
EN 48 HORAS





MAMPARA ESTANDAR

CODIGO	RANGO	TRANSPARENTE	DECORADO		CON ESPANSOR MAGNETICO	TRANSPARENTE
			GRUPO I	GRUPO II		
PAP050	53-55	259 €	315 €	360 €	55-58	322 €
PAP055	58-60	263 €	318 €	363 €	60-63	325 €
PAP060	63-65	267 €	330 €	375 €	65-68	330 €
PAP065	68-70	271 €	333 €	378 €	70-73	333 €
PAP070	73-75	279 €	341 €	386 €	75-78	341 €
PAP075	78-80	282 €	360 €	405 €	80-83	344 €
PAP080	83-85	286 €	386 €	431 €	85-88	348 €
PAP085	88-90	308 €	409 €	454 €	90-93	370 €

ESPECIALES A MEDIDA

CODIGO	RANGO	TRANSPARENTE	DECORADO	
			GRUPO I	GRUPO II
PAPS050	53-54,5	337 €	409 €	454 €
PAPS070	58-59,5	362 €	443 €	488 €
PAPS090	63-64,5	401 €	532 €	577 €

INCREMENTO PERFILERÍA COLORES

NEGRO  + 45€ ORO MATE  + 150€ ORO BRILLO  + 150€ ORO ROSA  + 150€**MAMPARA DE BAÑO SERIE PADEL 100A**

BATHROOM SCREEN PADEL 100A SERIES | ÉCRAN DE SALLE DE BAIN SÉRIE PADEL 100A







MAMPARA ESTANDAR

CÓDIGO	MEDIDA	TRANSPARENTE	DECORADO	
			GRUPO I	GRUPO II
PA1070A	HASTA 70	421 €	512 €	557 €
PA1090A	HASTA 90	443 €	539 €	584 €
PA1120A	HASTA 120	475 €	593 €	638 €
PA1140A	HASTA 140	495 €	620 €	665 €
PA1160A	HASTA 160	517 €	673 €	718 €
PA1180A	HASTA 180	538 €	727 €	772 €
PA1200A	HASTA 200	559 €	765 €	810 €

ESPECIALES A MEDIDA

CÓDIGO	MEDIDA	TRANSPARENTE	DECORADO	
			GRUPO I	GRUPO II
PAS1070A	HASTA 70	506 €	615 €	660 €
PAS1090A	HASTA 90	532 €	647 €	692 €
PAS1120A	HASTA 120	570 €	711 €	756 €
PAS1140A	HASTA 140	594 €	744 €	789 €
PAS1160A	HASTA 160	620 €	808 €	898 €
PAS1180A	HASTA 180	646 €	873 €	963 €
PAS1200A	HASTA 200	670 €	918 €	1.008 €

INCREMENTO PERFILERÍA COLORES

NEGRO  + 45€ ORO MATE  + 150€ ORO BRILLO  + 150€ ORO ROSA  + 150€**MAMPARA DE BAÑO SERIE PADEL 100B**

BATHROOM SCREEN PADEL 100B SERIES | ÉCRAN DE SALLE DE BAIN SÉRIE PADEL 100B







MAMPARA ESTANDAR

CÓDIGO	MEDIDA	TRANSPARENTE	DECORADO	
			GRUPO I	GRUPO II
PA1070B	HASTA 70	421 €	512 €	557 €
PA1090B	HASTA 90	443 €	539 €	584 €
PA1120B	HASTA 120	475 €	593 €	638 €
PA1140B	HASTA 140	495 €	620 €	665 €
PA1160B	HASTA 160	517 €	673 €	718 €
PA1180B	HASTA 180	538 €	727 €	772 €
PA1200B	HASTA 200	559 €	765 €	810 €

ESPECIALES A MEDIDA

CÓDIGO	MEDIDA	TRANSPARENTE	DECORADO	
			GRUPO I	GRUPO II
PAS1070B	HASTA 70	506 €	615 €	660 €
PAS1090B	HASTA 90	532 €	647 €	692 €
PAS1120B	HASTA 120	570 €	711 €	756 €
PAS1140B	HASTA 140	594 €	744 €	789 €
PAS1160B	HASTA 160	620 €	808 €	898 €
PAS1180B	HASTA 180	646 €	873 €	963 €
PAS1200B	HASTA 200	670 €	918 €	1.008 €

INCREMENTO PERFILERÍA COLORES

NEGRO  + 45€ ORO MATE  + 150€ ORO BRILLO  + 150€ ORO ROSA  + 150€

MAMPARA DE BAÑO SERIE PADEL 200A

BATHROOM SCREEN PADEL 200A SERIES | ÉCRAN DE SALLE DE BAIN SÉRIE PADEL 200A



INCREMENTO PERFILERÍA COLORES

NEGRO + 65€ ORO MATE + 200€ ORO BRILLO + 200€ ORO ROSA + 200€

MAMPARA ESTANDAR

CÓDIGO	MEDIDA	TRANSPARENTE	DECORADO	
			GRUPO I	GRUPO II
PA2100A	HASTA 100	489 €	606 €	651 €
PA2120A	HASTA 120	504 €	628 €	673 €
PA2140A	HASTA 140	527 €	657 €	702 €
PA2160A	HASTA 160	542 €	705 €	750 €
PA2180A	HASTA 180	564 €	733 €	778 €

ESPECIALES A MEDIDA

CÓDIGO	MEDIDA	TRANSPARENTE	DECORADO	
			GRUPO I	GRUPO II
PAS2100A	HASTA 100	587 €	727 €	772 €
PAS2120A	HASTA 120	605 €	753 €	798 €
PAS2140A	HASTA 140	632 €	789 €	834 €
PAS2160A	HASTA 160	650 €	846 €	936 €
PAS2180A	HASTA 180	677 €	880 €	970 €

MAMPARA DE BAÑO SERIE PADEL 200B

BATHROOM SCREEN PADEL 200B SERIES | ÉCRAN DE SALLE DE BAIN SÉRIE PADEL 200B



MAMPARA ESTANDAR

CÓDIGO	MEDIDA	TRANSPARENTE	DECORADO	
			GRUPO I	GRUPO II
PA2100B	HASTA 100	673 €	818 €	863 €
PA2120B	HASTA 120	693 €	845 €	890 €
PA2140B	HASTA 140	714 €	872 €	917 €
PA2160B	HASTA 160	734 €	921 €	966 €
PA2180B	HASTA 180	756 €	948 €	993 €
PA2200B	HASTA 200	776 €	998 €	1.043 €
PA2220B	HASTA 220	796 €	1.025 €	1.070 €

ESPECIALES A MEDIDA

CÓDIGO	MEDIDA	TRANSPARENTE	DECORADO	
			GRUPO I	GRUPO II
PAS2100B	HASTA 100	808 €	982 €	1.027 €
PAS2120B	HASTA 120	832 €	1.014 €	1.059 €
PAS2140B	HASTA 140	857 €	1.047 €	1.092 €
PAS2160B	HASTA 160	881 €	1.105 €	1.195 €
PAS2180B	HASTA 180	907 €	1.138 €	1.228 €
PAS2200B	HASTA 200	931 €	1.198 €	1.288 €
PAS2220B	HASTA 220	956 €	1.230 €	1.320 €

INCREMENTO PERFILERÍA COLORES

NEGRO + 65€ ORO MATE + 200€ ORO BRILLO + 200€ ORO ROSA + 200€

MAMPARA DE BAÑO SERIE PADEL 200AB

BATHROOM SCREEN PADEL 200AB SERIES | ÉCRAN DE SALLE DE BAIN SÉRIE PADEL 200AB



MAMPARA ESTANDAR

CÓDIGO	MEDIDA	TRANSPARENTE	DECORADO	
			GRUPO I	GRUPO II
PA2100AB	HASTA 100	596 €	713 €	758 €
PA2120AB	HASTA 120	616 €	763 €	808 €
PA2140AB	HASTA 140	636 €	790 €	835 €
PA2160AB	HASTA 160	657 €	828 €	873 €
PA2180AB	HASTA 180	679 €	854 €	899 €
PA2200AB	HASTA 200	699 €	913 €	958 €
PA2220AB	HASTA 220	719 €	940 €	985 €

ESPECIALES A MEDIDA

CÓDIGO	MEDIDA	TRANSPARENTE	DECORADO	
			GRUPO I	GRUPO II
PAS2100AB	HASTA 100	715 €	855 €	900 €
PAS2120AB	HASTA 120	740 €	915 €	960 €
PAS2140AB	HASTA 140	763 €	948 €	993 €
PAS2160AB	HASTA 160	789 €	994 €	1.084 €
PAS2180AB	HASTA 180	814 €	1.025 €	1.115 €
PAS2200AB	HASTA 200	839 €	1.096 €	1.186 €
PAS2220AB	HASTA 220	863 €	1.128 €	1.218 €

INCREMENTO PERFILERÍA COLORES

NEGRO + 65€ ORO MATE + 200€ ORO BRILLO + 200€ ORO ROSA + 200€

MAMPARA DE BAÑO SERIE PADEL 200AC

BATHROOM SCREEN PADEL 200AC SERIES | ÉCRAN DE SALLE DE BAIN SÉRIE PADEL 200AC







MAMPARA ESTANDAR

CÓDIGO	MEDIDA A+B	TRANSPARENTE	DECORADO	
			GRUPO I	GRUPO II
PA2100AC	HASTA 100	630 €	735 €	780 €
PA2120AC	HASTA 120	650 €	785 €	830 €
PA2140AC	HASTA 140	670 €	812 €	857 €
PA2160AC	HASTA 160	691 €	851 €	896 €
PA2180AC	HASTA 180	713 €	877 €	922 €
PA2200AC	HASTA 200	733 €	936 €	981 €
PA2220AC	HASTA 220	753 €	963 €	1.008 €

ESPECIALES A MEDIDA

CÓDIGO	MEDIDA A+B	TRANSPARENTE	DECORADO	
			GRUPO I	GRUPO II
PAS2100AC	HASTA 100	756 €	882 €	927 €
PAS2120AC	HASTA 120	780 €	942 €	987 €
PAS2140AC	HASTA 140	804 €	975 €	1.020 €
PAS2160AC	HASTA 160	829 €	1.021 €	1.111 €
PAS2180AC	HASTA 180	855 €	1.052 €	1.097 €
PAS2200AC	HASTA 200	880 €	1.123 €	1.168 €
PAS2220AC	HASTA 220	904 €	1.156 €	1.201 €

INCREMENTO PERFILERÍA COLORES

 NEGRO  +90 € ORO MATE  ND ORO BRILLO  ND ORO ROSA  ND
MAMPARA DE BAÑO SERIE PADEL 300A

BATHROOM SCREEN PADEL 300A SERIES | ÉCRAN DE SALLE DE BAIN SÉRIE PADEL 300A







MAMPARA ESTANDAR

CÓDIGO	MEDIDA A+B	TRANSPARENTE	DECORADO	
			GRUPO I	GRUPO II
PA3100A	HASTA 100	519 €	630 €	675 €
PA3120A	HASTA 120	535 €	651 €	696 €
PA3140A	HASTA 140	556 €	681 €	726 €
PA3160A	HASTA 160	572 €	729 €	774 €

ESPECIALES A MEDIDA

CÓDIGO	MEDIDA A+B	TRANSPARENTE	DECORADO	
			GRUPO I	GRUPO II
PAS3100A	HASTA 100	623 €	756 €	801 €
PAS3120A	HASTA 120	642 €	782 €	827 €
PAS3140A	HASTA 140	668 €	817 €	862 €
PAS3160A	HASTA 160	687 €	874 €	964 €

INCREMENTO PERFILERÍA COLORES

 NEGRO  + 65€ ORO MATE  + 200€ ORO BRILLO  + 200€ ORO ROSA  +200€
MAMPARA DE BAÑO SERIE PADEL 300B

BATHROOM SCREEN PADEL 300B SERIES | ÉCRAN DE SALLE DE BAIN SÉRIE PADEL 300B







MAMPARA ESTANDAR

CÓDIGO	MEDIDA A+B	TRANSPARENTE	DECORADO	
			GRUPO I	GRUPO II
PA3120B	HASTA 120	693 €	845 €	890 €
PA3140B	HASTA 140	714 €	872 €	917 €
PA3160B	HASTA 160	734 €	900 €	945 €
PA3180B	HASTA 180	756 €	948 €	993 €
PA3200B	HASTA 200	776 €	976 €	1.021 €
PA3220B	HASTA 220	796 €	1.025 €	1.070 €

ESPECIALES A MEDIDA

CÓDIGO	MEDIDA A+B	TRANSPARENTE	DECORADO	
			GRUPO I	GRUPO II
PAS3120B	HASTA 120	832 €	1.014 €	1.059 €
PAS3140B	HASTA 140	857 €	1.047 €	1.092 €
PAS3160B	HASTA 160	881 €	1.080 €	1.170 €
PAS3180B	HASTA 180	907 €	1.138 €	1.228 €
PAS3200B	HASTA 200	931 €	1.171 €	1.261 €
PAS3220B	HASTA 220	956 €	1.230 €	1.320 €

INCREMENTO PERFILERÍA COLORES

 NEGRO  + 65€ ORO MATE  + 200€ ORO BRILLO  + 200€ ORO ROSA  +200€

MAMPARA DE BAÑO SERIE PADEL 300AB

BATHROOM SCREEN PADEL 300AB SERIES | ÉCRAN DE SALLE DE BAIN SÉRIE PADEL 300AB



MAMPARA ESTANDAR

CÓDIGO	MEDIDA A+B	TRANSPARENTE	DECORADO	
			GRUPO I	GRUPO II
PA3100AB	HASTA 100	596 €	713 €	758 €
PA3120AB	HASTA 120	616 €	763 €	808 €
PA3140AB	HASTA 140	637 €	790 €	835 €
PA3160AB	HASTA 160	657 €	828 €	873 €
PA3180AB	HASTA 180	679 €	854 €	899 €
PA3200AB	HASTA 200	699 €	913 €	958 €
PA3220AB	HASTA 220	719 €	940 €	985 €

ESPECIALES A MEDIDA

CÓDIGO	MEDIDA A+B	TRANSPARENTE	DECORADO	
			GRUPO I	GRUPO II
PAS3100AB	HASTA 100	715 €	855 €	900 €
PAS3120AB	HASTA 120	740 €	915 €	960 €
PAS3140AB	HASTA 140	764 €	948 €	993 €
PAS3160AB	HASTA 160	789 €	994 €	1.084 €
PAS3180AB	HASTA 180	814 €	1.025 €	1.115 €
PAS3200AB	HASTA 200	839 €	1.096 €	1.186 €
PAS3220AB	HASTA 220	863 €	1.128 €	1.218 €

INCREMENTO PERFILERÍA COLORES

NEGRO + 65€ ORO MATE + 200€ ORO BRILLO + 200€ ORO ROSA + 200€

MAMPARA DE BAÑO SERIE PADEL 400A

BATHROOM SCREEN PADEL 400A SERIES | ÉCRAN DE SALLE DE BAIN SÉRIE PADEL 400A



MAMPARA ESTANDAR

CÓDIGO	MEDIDA A+B	TRANSPARENTE	DECORADO	
			GRUPO I	GRUPO II
PA4100A	HASTA 100	452 €	552 €	597 €
PA4120A	HASTA 120	472 €	590 €	635 €
PA4140A	HASTA 140	493 €	616 €	661 €
PA4160A	HASTA 160	513 €	670 €	715 €
PA4180A	HASTA 180	534 €	724 €	769 €
PA4200A	HASTA 200	554 €	760 €	805 €
PA4220A	HASTA 220	574 €	786 €	831 €

ESPECIALES A MEDIDA

CÓDIGO	MEDIDA A+B	TRANSPARENTE	DECORADO	
			GRUPO I	GRUPO II
PAS4100A	HASTA 100	542 €	662 €	707 €
PAS4120A	HASTA 120	567 €	708 €	753 €
PAS4140A	HASTA 140	591 €	740 €	785 €
PAS4160A	HASTA 160	616 €	804 €	894 €
PAS4180A	HASTA 180	640 €	869 €	959 €
PAS4200A	HASTA 200	665 €	912 €	1.002 €
PAS4220A	HASTA 220	689 €	944 €	1.034 €

INCREMENTO PERFILERÍA COLORES

NEGRO + 65€ ORO MATE + 200€ ORO BRILLO + 200€ ORO ROSA + 200€

MAMPARA DE BAÑO SERIE PADEL 400B

BATHROOM SCREEN PADEL 400B SERIES | ÉCRAN DE SALLE DE BAIN SÉRIE PADEL 400B



MAMPARA ESTANDAR

CÓDIGO	MEDIDA A+B	TRANSPARENTE	DECORADO	
			GRUPO I	GRUPO II
PA4100B	HASTA 100	529 €	646 €	691 €
PA4120B	HASTA 120	550 €	696 €	741 €
PA4140B	HASTA 140	570 €	722 €	767 €
PA4160B	HASTA 160	590 €	760 €	805 €
PA4180B	HASTA 180	611 €	787 €	832 €
PA4200B	HASTA 200	631 €	846 €	891 €
PA4220B	HASTA 220	651 €	874 €	919 €

ESPECIALES A MEDIDA

CÓDIGO	MEDIDA A+B	TRANSPARENTE	DECORADO	
			GRUPO I	GRUPO II
PAS4100B	HASTA 100	635 €	775 €	820 €
PAS4120B	HASTA 120	659 €	835 €	880 €
PAS4140B	HASTA 140	684 €	866 €	911 €
PAS4160B	HASTA 160	708 €	912 €	1.002 €
PAS4180B	HASTA 180	733 €	945 €	1.035 €
PAS4200B	HASTA 200	757 €	1.016 €	1.106 €
PAS4220B	HASTA 220	782 €	1.048 €	1.138 €

INCREMENTO PERFILERÍA COLORES

NEGRO + 65€ ORO MATE + 200€ ORO BRILLO + 200€ ORO ROSA + 200€

MAMPARA DE BAÑO SERIE PADEL 400C

BATHROOM SCREEN PADEL 400C SERIES | ÉCRAN DE SALLE DE BAIN SÉRIE PADEL 400C







MAMPARA ESTANDAR

CÓDIGO	MEDIDA A+B	TRANSPARENTE	DECORADO	
			GRUPO I	GRUPO II
PA4100C	HASTA 100	497 €	586 €	631 €
PA4120C	HASTA 120	518 €	624 €	669 €
PA4140C	HASTA 140	538 €	650 €	695 €
PA4160C	HASTA 160	559 €	704 €	749 €
PA4180C	HASTA 180	579 €	758 €	803 €
PA4200C	HASTA 200	599 €	794 €	839 €
PA4220C	HASTA 220	620 €	820 €	865 €

ESPECIALES A MEDIDA

CÓDIGO	MEDIDA A+B	TRANSPARENTE	DECORADO	
			GRUPO I	GRUPO II
PAS4100C	HASTA 100	597 €	703 €	748 €
PAS4120C	HASTA 120	621 €	749 €	794 €
PAS4140C	HASTA 140	646 €	780 €	825 €
PAS4160C	HASTA 160	670 €	844 €	934 €
PAS4180C	HASTA 180	695 €	910 €	1.000 €
PAS4200C	HASTA 200	719 €	953 €	1.043 €
PAS4220C	HASTA 220	744 €	984 €	1.074 €

INCREMENTO PERFILERÍA COLORES

 NEGRO  +90 € ORO MATE  ND ORO BRILLO  ND ORO ROSA  ND
MAMPARA DE BAÑO SERIE PADEL 400CB

BATHROOM SCREEN PADEL 400CB SERIES | ÉCRAN DE SALLE DE BAIN SÉRIE PADEL 400CB







MAMPARA ESTANDAR

CÓDIGO	MEDIDA A+B	TRANSPARENTE	DECORADO	
			GRUPO I	GRUPO II
PA4100CB	HASTA 100	574 €	680 €	725 €
PA4120CB	HASTA 120	595 €	730 €	775 €
PA4140CB	HASTA 140	615 €	756 €	801 €
PA4160CB	HASTA 160	636 €	794 €	839 €
PA4180CB	HASTA 180	658 €	821 €	866 €
PA4200CB	HASTA 200	676 €	880 €	925 €
PA4220CB	HASTA 220	697 €	905 €	950 €

ESPECIALES A MEDIDA

CÓDIGO	MEDIDA A+B	TRANSPARENTE	DECORADO	
			GRUPO I	GRUPO II
PAS4100CB	HASTA 100	689 €	816 €	861 €
PAS4120CB	HASTA 120	714 €	876 €	921 €
PAS4140CB	HASTA 140	738 €	907 €	952 €
PAS4160CB	HASTA 160	763 €	953 €	1.043 €
PAS4180CB	HASTA 180	749 €	986 €	1.076 €
PAS4200CB	HASTA 200	812 €	1.056 €	1.146 €
PAS4220CB	HASTA 220	836 €	1.086 €	1.176 €

INCREMENTO PERFILERÍA COLORES

 NEGRO  +90 € ORO MATE  ND ORO BRILLO  ND ORO ROSA  ND
MAMPARA DE BAÑO SERIE PADEL 800

BATHROOM SCREEN PADEL 800 SERIES | ÉCRAN DE SALLE DE BAIN SÉRIE PADEL 800







MAMPARA ESTANDAR

CÓDIGO	MEDIDA A+B	TRANSPARENTE	DECORADO	
			GRUPO I	GRUPO II
PA8100A	HASTA 100	642 €	759 €	804 €
PA8120A	HASTA 120	663 €	809 €	854 €
PA8140A	HASTA 140	683 €	835 €	880 €
PA8160A	HASTA 160	704 €	874 €	919 €
PA8180A	HASTA 180	724 €	901 €	946 €
PA8200A	HASTA 200	744 €	960 €	1.005 €
PA8220A	HASTA 220	765 €	987 €	1.032 €

ESPECIALES A MEDIDA

CÓDIGO	MEDIDA A+B	TRANSPARENTE	DECORADO	
			GRUPO I	GRUPO II
PAS8100A	HASTA 100	748 €	888 €	933 €
PAS8120A	HASTA 120	773 €	948 €	993 €
PAS8140A	HASTA 140	798 €	979 €	1.024 €
PAS8160A	HASTA 160	821 €	1.025 €	1.115 €
PAS8180A	HASTA 180	846 €	1.058 €	1.148 €
PAS8200A	HASTA 200	870 €	1.128 €	1.218 €
PAS8220A	HASTA 220	895 €	1.161 €	1.251 €

INCREMENTO PERFILERÍA COLORES

 NEGRO  +90 € ORO MATE  ND ORO BRILLO  ND ORO ROSA  ND

MAMPARA DE BAÑO SERIE PADEL 900

BATHROOM SCREEN PADEL 900 SERIES | ÉCRAN DE SALLE DE BAIN SÉRIE PADEL 900



MAMPARA ESTANDAR

CÓDIGO	MEDIDA A+B	TRANSPARENTE	DECORADO	
			GRUPO I	GRUPO II
PA9100	HASTA 100	529 €	646 €	691 €
PA9120	HASTA 120	550 €	696 €	741 €
PA9140	HASTA 140	570 €	722 €	767 €
PA9160	HASTA 160	590 €	760 €	805 €
PA9180	HASTA 180	611 €	787 €	832 €
PA9200	HASTA 200	631 €	846 €	891 €
PA9220	HASTA 220	651 €	874 €	919 €

ESPECIALES A MEDIDA

CÓDIGO	MEDIDA	TRANSPARENTE	DECORADO	
			GRUPO I	GRUPO II
PAS9100	HASTA 100	635 €	775 €	820 €
PAS9120	HASTA 120	659 €	835 €	880 €
PAS9140	HASTA 140	684 €	866 €	911 €
PAS9160	HASTA 160	708 €	912 €	1.002 €
PAS9180	HASTA 180	733 €	945 €	1.035 €
PAS9200	HASTA 200	757 €	1.016 €	1.106 €
PAS9220	HASTA 220	782 €	1.048 €	1.138 €

INCREMENTO PERFILERÍA COLORES

NEGRO + 65€ ORO MATE + 200€ ORO BRILLO + 200€ ORO ROSA + 200€

MAMPARA DE BAÑO SERIE PADEL Z

BATHROOM SCREEN PADEL Z SERIES | ÉCRAN DE SALLE DE BAIN SÉRIE PADEL Z



MAMPARA ESTANDAR

CÓDIGO	MEDIDA	TRANSPARENTE	DECORADO	
			GRUPO I	GRUPO II
PAZ200	HASTA 200	897 €	1.110 €	1.155 €
PAZ250	HASTA 250	965 €	1.167 €	1.212 €
PAZ300	HASTA 300	1.033 €	1.224 €	1.269 €

ESPECIALES A MEDIDA

CÓDIGO	MEDIDA	TRANSPARENTE	DECORADO	
			GRUPO I	GRUPO II
PAZS200	HASTA 200	1.077 €	1.332 €	1.422 €
PAZS250	HASTA 250	1.158 €	1.400 €	1.520 €
PAZS300	HASTA 300	1.240 €	1.468 €	1.618 €

ESPECIALES A MEDIDA



CÓDIGO	MEDIDA	TRANSPARENTE	DECORADO	
			GRUPO I	GRUPO II
PAZS250B	HASTA 250	1.109 €	1.443 €	1.563 €
PAZS300B	HASTA 300	1.177 €	1.511 €	1.631 €
PAZS350B	HASTA 350	1.245 €	1.579 €	1.729 €
PAZS400B	HASTA 400	1.313 €	1.647 €	1.797 €

ESPECIALES A MEDIDA



CÓDIGO	MEDIDA	TRANSPARENTE	DECORADO	
			GRUPO I	GRUPO II
PAZS250AB	HASTA 250	1.240 €	1.559 €	1.679 €
PAZS300AB	HASTA 300	1.307 €	1.627 €	1.747 €
PAZS350AB	HASTA 350	1.375 €	1.695 €	1.845 €
PAZS400AB	HASTA 400	1.443 €	1.763 €	1.913 €

INCREMENTO PERFILERÍA COLORES

NEGRO + 100€ ORO MATE + 300€ ORO BRILLO + 300€ ORO ROSA + 300€

TENSORES OPCIONALES

- Plata 40 €. Negro 50 €. Resto de colores 70 €.

DIMENSIONES MÁXIMAS MAMPARAS A MEDIDA

- Altura máxima 2200 mm
- Ancho máximo PUERTA 900 mm

ESPECIFICACIONES TRAMITACIÓN PEDIDOS

- Indicar medida de hueco real para adaptar la mejor opción y evitar errores de códigos
- Indicar posición de puerta mirando la mampara desde fuera (mano)
- Especificar cuando el plato este enrasado a suelo o sea de obra.

PLAZO DE EXPEDICIONES

- Plazo de expediciones en todas las modalidades 15 días.
- Cristales especiales y decorados (GRUPO 2, MATE Y PARSOLES) 15 días

ACORD

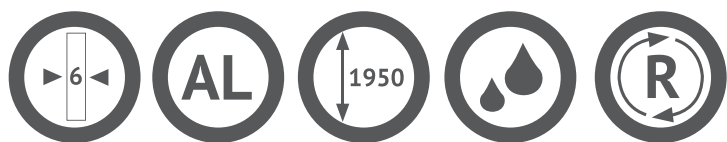





Modelo **ACORD 300**. Mampara Totalmente **Abatible**. Entrada Vertice.



MAMPARA DE BAÑO SERIE ACORD 100B

BATHROOM SCREEN ACORD 100B SERIES | ÉCRAN DE SALLE DE BAIN SÉRIE ACORD 100B



MAMPARA ESTANDAR

CÓDIGO	MEDIDA	TRANSPARENTE	DECORADO	
			GRUPO I	GRUPO II
AC1070B	HASTA 70	440 €	512 €	557 €
AC1090B	HASTA 90	461 €	539 €	584 €
AC1100B	HASTA 100	483 €	593 €	638 €

ESPECIALES A MEDIDA

CÓDIGO	MEDIDA	TRANSPARENTE	DECORADO	
			GRUPO I	GRUPO II
ACS1070B	HASTA 70	528 €	615 €	660 €
ACS1090B	HASTA 90	553 €	647 €	692 €
ACS1120B	HASTA 120	579 €	711 €	756 €

INCREMENTO PERFILERÍA COLORESNEGRO  + 45€**MAMPARA DE BAÑO SERIE ACORD 200B**

BATHROOM SCREEN ACORD 200B SERIES | ÉCRAN DE SALLE DE BAIN SÉRIE ACORD 200B



MAMPARA ESTANDAR

CÓDIGO	MEDIDA	TRANSPARENTE	DECORADO	
			GRUPO I	GRUPO II
AC2100B	HASTA 100	642 €	787 €	832 €
AC2120B	HASTA 120	663 €	815 €	860 €
AC2140B	HASTA 140	684 €	842 €	887 €
AC2160B	HASTA 160	706 €	893 €	983 €
AC2180B	HASTA 180	726 €	920 €	1.010 €
AC2200B	HASTA 200	748 €	970 €	1.060 €

ESPECIALES A MEDIDA

CÓDIGO	MEDIDA	TRANSPARENTE	DECORADO	
			GRUPO I	GRUPO II
ACS2100B	HASTA 100	771 €	945 €	990 €
ACS2120B	HASTA 120	795 €	978 €	1.023 €
ACS2140B	HASTA 140	821 €	1.010 €	1.055 €
ACS2160B	HASTA 160	847 €	1.071 €	1.161 €
ACS2180B	HASTA 180	872 €	1.104 €	1.194 €
ACS2220B	HASTA 220	897 €	1.164 €	1.254 €

INCREMENTO PERFILERÍA COLORESNEGRO  + 65€**MAMPARA DE BAÑO SERIE ACORD 300B**

BATHROOM SCREEN ACORD 300B SERIES | ÉCRAN DE SALLE DE BAIN SÉRIE ACORD 300B



MAMPARA ESTANDAR

CÓDIGO	MEDIDA A+B	TRANSPARENTE	DECORADO	
			GRUPO I	GRUPO II
AC3100B	HASTA 100	663 €	815 €	860 €
AC3120B	HASTA 120	684 €	842 €	887 €
AC3140B	HASTA 140	706 €	870 €	915 €
AC3160B	HASTA 160	726 €	920 €	1.010 €
AC3180B	HASTA 180	748 €	947 €	1.037 €
AC3200B	HASTA 200	768 €	997 €	1.087 €

ESPECIALES A MEDIDA

CÓDIGO	MEDIDA A+B	TRANSPARENTE	DECORADO	
			GRUPO I	GRUPO II
ACS3100B	HASTA 100	795 €	978 €	1.023 €
ACS3120B	HASTA 120	821 €	1.010 €	1.055 €
ACS3140B	HASTA 140	847 €	1.044 €	1.089 €
ACS3160B	HASTA 160	872 €	1.104 €	1.194 €
ACS3180B	HASTA 180	897 €	1.137 €	1.227 €
ACS3200B	HASTA 200	922 €	1.196 €	1.286 €

INCREMENTO PERFILERÍA COLORESNEGRO  + 65€

MAMPARA DE BAÑO SERIE ACORD 300AB

BATHROOM SCREEN ACORD 300AB SERIES | ÉCRAN DE SALLE DE BAIN SÉRIE ACORD 300AB



MAMPARA ESTANDAR

CÓDIGO	MEDIDA A+B	TRANSPARENTE	DECORADO	
			GRUPO I	GRUPO II
AC3120AB	HASTA 120	693 €	811 €	856 €
AC3140AB	HASTA 140	715 €	861 €	906 €
AC3160AB	HASTA 160	735 €	887 €	977 €
AC3180AB	HASTA 180	780 €	927 €	1.017 €
AC3200AB	HASTA 200	790 €	993 €	1.083 €
AC3220AB	HASTA 220	799 €	1.015 €	1.105 €

ESPECIALES A MEDIDA

CÓDIGO	MEDIDA A+B	TRANSPARENTE	DECORADO	
			GRUPO I	GRUPO II
ACS3120AB	HASTA 120	832 €	973 €	1.018 €
ACS3140AB	HASTA 140	858 €	1.033 €	1.078 €
ACS3160AB	HASTA 160	882 €	1.065 €	1.155 €
ACS3180AB	HASTA 180	935 €	1.112 €	1.202 €
ACS3200AB	HASTA 200	948 €	1.191 €	1.281 €
ACS3220AB	HASTA 220	959 €	1.218 €	1.308 €

**INCREMENTO PERFILERÍA COLORES**NEGRO  + 65€**MAMPARA DE BAÑO SERIE ACORD 400**

BATHROOM SCREEN ACORD 400 SERIES | ÉCRAN DE SALLE DE BAIN SÉRIE ACORD 400



MAMPARA ESTANDAR

CÓDIGO	MEDIDA A+B	TRANSPARENTE	DECORADO	
			GRUPO I	GRUPO II
AC4100	HASTA 100	509 €	627 €	672 €
AC4120	HASTA 120	530 €	676 €	721 €
AC4140	HASTA 140	552 €	704 €	749 €
AC4160	HASTA 160	572 €	742 €	832 €
AC4180	HASTA 180	594 €	770 €	860 €
AC4200	HASTA 200	615 €	827 €	917 €
AC4220	HASTA 220	636 €	858 €	948 €

ESPECIALES A MEDIDA

CÓDIGO	MEDIDA A+B	TRANSPARENTE	DECORADO	
			GRUPO I	GRUPO II
ACS4100	HASTA 100	610 €	752 €	797 €
ACS4120	HASTA 120	636 €	812 €	857 €
ACS4140	HASTA 140	662 €	844 €	889 €
ACS4160	HASTA 160	687 €	891 €	981 €
ACS4180	HASTA 180	712 €	925 €	1.015 €
ACS4200	HASTA 200	738 €	993 €	1.083 €
ACS4220	HASTA 220	763 €	1.029 €	1.119 €

**INCREMENTO PERFILERÍA COLORES**NEGRO  + 65€**MAMPARA DE BAÑO SERIE ACORD 400C**

BATHROOM SCREEN ACORD 400C SERIES | ÉCRAN DE SALLE DE BAIN SÉRIE ACORD 400C



MAMPARA ESTANDAR

CÓDIGO	MEDIDA A+B	TRANSPARENTE	DECORADO	
			GRUPO I	GRUPO II
AC4100C	HASTA 100	554 €	661 €	706 €
AC4120C	HASTA 120	576 €	710 €	755 €
AC4140C	HASTA 140	597 €	738 €	783 €
AC4160C	HASTA 160	617 €	776 €	866 €
AC4180C	HASTA 180	639 €	804 €	894 €
AC4200C	HASTA 200	661 €	861 €	951 €
AC4220C	HASTA 220	704 €	892 €	982 €

ESPECIALES A MEDIDA

CÓDIGO	MEDIDA A+B	TRANSPARENTE	DECORADO	
			GRUPO I	GRUPO II
ACS4100C	HASTA 100	665 €	793 €	838 €
ACS4120C	HASTA 120	691 €	852 €	897 €
ACS4140C	HASTA 140	717 €	885 €	930 €
ACS4160C	HASTA 160	741 €	931 €	1.021 €
ACS4180C	HASTA 180	767 €	965 €	1.055 €
ACS4200C	HASTA 200	793 €	1.033 €	1.123 €
ACS4220C	HASTA 220	844 €	1.070 €	1.160 €

**INCREMENTO PERFILERÍA COLORES**NEGRO  + 90€

MAMPARA DE BAÑO SERIE ACORD 900A

BATHROOM SCREEN ACORD 900A SERIES | ÉCRAN DE SALLE DE BAIN SÉRIE ACORD 900A



MAMPARA ESTANDAR

CÓDIGO	MEDIDA A+B	TRANSPARENTE	DECORADO	
			GRUPO I	GRUPO II
AC9100A	HASTA 100	509 €	627 €	672 €
AC9120A	HASTA 120	530 €	676 €	721 €
AC9140A	HASTA 140	552 €	704 €	749 €
AC9160A	HASTA 160	572 €	742 €	832 €
AC9180A	HASTA 180	594 €	770 €	860 €
AC9200A	HASTA 200	615 €	829 €	919 €
AC9220A	HASTA 220	636 €	858 €	948 €

ESPECIALES A MEDIDA

CÓDIGO	MEDIDA A+B	TRANSPARENTE	DECORADO	
			GRUPO I	GRUPO II
ACS9100A	HASTA 100	610 €	752 €	797 €
ACS9120A	HASTA 120	636 €	812 €	857 €
ACS9140A	HASTA 140	662 €	844 €	889 €
ACS9160A	HASTA 160	687 €	891 €	981 €
ACS9180A	HASTA 180	712 €	925 €	1.015 €
ACS9200A	HASTA 200	738 €	995 €	1.085 €
ACS9220A	HASTA 220	763 €	1.029 €	1.119 €

INCREMENTO PERFILERÍA COLORES

NEGRO  + 65€**MAMPARA DE BAÑO SERIE ACORD 900B**

BATHROOM SCREEN ACORD 900B SERIES | ÉCRAN DE SALLE DE BAIN SÉRIE ACORD 900B



MAMPARA ESTANDAR

CÓDIGO	MEDIDA A+B	TRANSPARENTE	DECORADO	
			GRUPO I	GRUPO II
AC9100B	HASTA 100	593 €	709 €	754 €
AC9120B	HASTA 120	621 €	766 €	811 €
AC9140B	HASTA 140	648 €	800 €	845 €
AC9160B	HASTA 160	675 €	845 €	935 €
AC9180B	HASTA 180	704 €	879 €	969 €
AC9200B	HASTA 200	731 €	946 €	1.036 €
AC9220B	HASTA 220	758 €	980 €	1.070 €

ESPECIALES A MEDIDA

CÓDIGO	MEDIDA A+B	TRANSPARENTE	DECORADO	
			GRUPO I	GRUPO II
ACS9100B	HASTA 100	711 €	851 €	896 €
ACS9120B	HASTA 120	745 €	919 €	964 €
ACS9140B	HASTA 140	778 €	960 €	1.005 €
ACS9160B	HASTA 160	810 €	1.014 €	1.104 €
ACS9180B	HASTA 180	844 €	1.055 €	1.145 €
ACS9200B	HASTA 200	877 €	1.135 €	1.225 €
ACS9220B	HASTA 220	910 €	1.176 €	1.266 €

INCREMENTO PERFILERÍA COLORES

NEGRO  + 65€

TENSORES OPCIONALES

- Plata 40 €. Negro 50 €. Resto de colores 70 €.

DIMENSIONES MÁXIMAS MAMPARAS A MEDIDA

- Altura máxima 2200 mm
- Ancho máximo 1200 mm

ESPECIFICACIONES TRAMITACIÓN PEDIDOS

- Indicar medida de hueco real para adaptar la mejor opción y evitar errores de códigos
- Indicar posición de puerta mirando la mampara desde fuera (mano)
- Especificar cuando el plato este enrasado a suelo o sea de obra.

PLAZO DE EXPEDICIONES

- Plazo de expediciones en todas las modalidades 15 días.
- Cristales especiales y decorados (GRUPO 2, MATE Y PARSOLES) 15 días

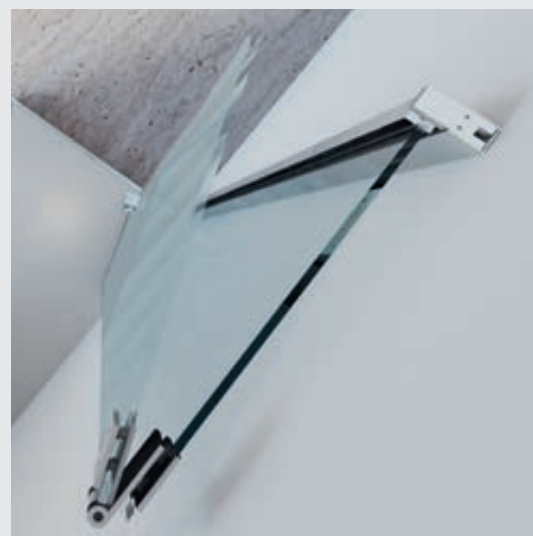



DUPLEX







Modelo **DUPLEX 400**. Mampara **Abatible**. Entrada Frontal.



Modelo **DUPLEX 100**. Mampara **Abatible**. Entrada Frontal. Decorado **TAIGA**.

MAMPARA DE BAÑO SERIE DUPLEX 100

BATHROOM SCREEN DUPLEX 100 SERIES | ÉCRAN DE SALLE DE BAIN SÉRIE DUPLEX 100



MAMPARA ESTANDAR

CÓDIGO	MEDIDA	RANGO INSTALACIÓN	TRANSPARENTE	DECORADO		APERTURA
				GRUPO I	GRUPO II	
DP0170	70	67-72	475 €	550 €	595 €	45
DP0180	80	77-82	499 €	573 €	618 €	55
DP0190	90	87-92	522 €	597 €	642 €	65
DP1100	100	97-102	546 €	621 €	666 €	74

ESPECIALES A MEDIDA

CÓDIGO	MEDIDA	TRANSPARENTE	DECORADO	
			GRUPO I	GRUPO II
DPS1070	HASTA 70	561 €	644 €	689 €
DPS1090	HASTA 90	590 €	696 €	741 €
DPS1100	HASTA 100	605 €	722 €	767 €

MAMPARA DE BAÑO SERIE DUPLEX 400

BATHROOM SCREEN DUPLEX 400 SERIES | ÉCRAN DE SALLE DE BAIN SÉRIE DUPLEX 400



MAMPARA ESTANDAR

CÓDIGO	MEDIDA	RANGO INSTALACIÓN	TRANSPARENTE	DECORADO		APERTURA
				GRUPO I	GRUPO II	
DP4077	70X70	67-72/67-69,5	670 €	806 €	851 €	45
DP4078	70X80	67-72/77-79,5	687 €	832 €	922 €	45
DP4079	70X90	67-72/87-89,5	712 €	866 €	956 €	45
DP4087	80X70	77-82/67-69,5	695 €	830 €	920 €	55
DP4088	80X80	77-82/77-79,5	712 €	857 €	947 €	55
DP4089	80X90	77-82/87-89,5	735 €	889 €	979 €	55
DP4097	90X70	87-92/67-69,5	718 €	854 €	944 €	65
DP4098	90X80	87-92/77-79,5	735 €	880 €	970 €	65
DP4099	90X90	87-92/87-89,5	759 €	913 €	1.003 €	65
DP4107	100X70	97-102/67-69,5	742 €	878 €	968 €	74
DP4108	100X80	97-102/77-79,5	759 €	904 €	994 €	74
DP4109	100X90	97-102/87-89,5	783 €	937 €	1.027 €	74

SÓLO LATERAL

CÓDIGO	MEDIDA	RANGO INSTALACIÓN	TRANSPARENTE	DECORADO	
				GRUPO I	GRUPO II
DP407	70	67-69,5	196 €	257 €	302 €
DP408	80	77,5-80	213 €	283 €	328 €
DP409	90	87,5-90	237 €	316 €	361 €

ESPECIALES A MEDIDA SÓLO LATERAL

CÓDIGO	MEDIDA	TRANSPARENTE	DECORADO	
			GRUPO I	GRUPO II
DPS405	HASTA 50	215 €	274 €	319 €
DPS407	HASTA 70	245 €	326 €	371 €
DPS409	HASTA 90	273 €	380 €	425 €
DPS411	HASTA 110	303 €	432 €	477 €



DIMENSIONES MÁXIMAS MAMPARAS A MEDIDA

- Altura máxima 1950 mm
- Ancho máximo 1100 mm

ESPECIFICACIONES TRAMITACIÓN PEDIDOS

- Indicar medida de hueco real para adaptar la mejor opción y evitar errores de códigos
- Indicar posición de puerta mirando la mampara desde fuera (mano)
- Especificar cuando el plato este enrasado a suelo o sea de obra.
- El precio del tratamiento antical por cada hoja será de 10 €

PLAZO DE EXPEDICIONES

- Transparentes 48 horas
- Decorados 5 días hábiles GRUPO 1 (EXCEPTO MATE Y PARSOLES)
- Cristales especiales y decorados (GRUPO 2, MATE Y PARSOLES) 15 días

MIXTA







Modelo **MIXTA B**. Mampara **Abatible** + Mampara **Corredera**. Entrada Vértice.



MAMPARA DE BAÑO SERIE MIXTA 300A

BATHROOM SCREEN MIXTA 300A SERIES | ÉCRAN DE SALLE DE BAIN SÉRIE MIXTA 300A



MAMPARA ESTANDAR

CÓDIGO	MEDIDA A+B	TRANSPARENTE	DECORADO	
			GRUPO I	GRUPO II
MI3140A	HASTA 140	657 €	793 €	838 €
MI3160A	HASTA 160	674 €	810 €	900 €
MI3180A	HASTA 180	691 €	838 €	928 €
MI3200A	HASTA 200	714 €	878 €	968 €

ESPECIALES A MEDIDA

CÓDIGO	MEDIDA	TRANSPARENTE	DECORADO	
			GRUPO I	GRUPO II
MIS3140A	HASTA 140	783 €	952 €	997 €
MIS3160A	HASTA 160	809 €	972 €	1.062 €
MIS3180A	HASTA 180	829 €	1.006 €	1.096 €
MIS3200A	HASTA 200	857 €	1.054 €	1.144 €

MAMPARA DE BAÑO SERIE MIXTA 300B

BATHROOM SCREEN MIXTA 300B SERIES | ÉCRAN DE SALLE DE BAIN SÉRIE MIXTA 300B



MAMPARA ESTANDAR

CÓDIGO	MEDIDA A+B	TRANSPARENTE	DECORADO	
			GRUPO I	GRUPO II
MI3140B	HASTA 140	816 €	952 €	997 €
MI3160B	HASTA 160	833 €	969 €	1.059 €
MI3180B	HASTA 180	850 €	997 €	1.087 €
MI3200B	HASTA 200	872 €	1.037 €	1.127 €

ESPECIALES A MEDIDA

CÓDIGO	MEDIDA	TRANSPARENTE	DECORADO	
			GRUPO I	GRUPO II
MIS3140B	HASTA 140	979 €	1.142 €	1.187 €
MIS3160B	HASTA 160	999 €	1.162 €	1.252 €
MIS3180B	HASTA 180	1.020 €	1.196 €	1.286 €
MIS3200B	HASTA 200	1.047 €	1.244 €	1.334 €

DIMENSIONES MÁXIMAS MAMPARAS A MEDIDA

- Altura máxima 2200 mm
- Ancho máximo LADO CORREDERA 1200 mm

ESPECIFICACIONES TRAMITACIÓN PEDIDOS

- Indicar medida de hueco real para adaptar la mejor opción y evitar errores de códigos
- Indicar posición de puerta mirando la mampara desde fuera (mano)
- Especificar cuando el plato este enrasado a suelo o sea de obra.

PLAZO DE EXPEDICIONES

- Plazo de expediciones en todas las modalidades 15 días.
- Cristales especiales y decorados (GRUPO 2, MATE Y PARSOLES) 15 días



WALL







Modelo **WALK-IN 100**. Panel **Fijo**. Decorado **TEX**.



Modelo **WALK-IN 200**. Panel **Fijo + Abatible**.

WALL





Modelo WALK-IN 100. Panel Fijo. Decorado VINTAGE. Impresión Digital.

WALL



Modelo **WALK-IN 100**. Panel **Fijo Enmarcado**. Perfilería **NEGRA**.



Modelo **WALK-IN 100**. Panel **Fijo**. Decorado **INDUSTRIAL**. Impresión Digital.

WALL



Modelo **WALK-IN 200 ESPECIAL**. Cristal Fijo sobre mocheta.



Modelo **VOS 200**. Panel **Fijo + Abatible**.

WALL

WALL XAHHA





Modelo **XAHA**. Perfilera oro.

WALL



Modelo XAHA 100. Panel Fijo a techo. Perfilera AZUL.



Modelo **WALK-IN 100**. Panel **Fijo Enmarcado**. Perfilería **NEGRA**. Cristal **Acanalado**.

MAMPARA DE BAÑO SERIE WALK-IN

BATHROOM SCREEN WALK-IN SERIES | ÉCRAN DE SALLE DE BAIN SÉRIE WALK-IN







MAMPARA ESTANDAR

CÓDIGO	MEDIDA	TRANSPARENTE	DECORADO	
			GRUPO I	GRUPO II
WK070	70	248 €	316 €	361 €
WK080	80	266 €	343 €	388 €
WK090	90	284 €	370 €	415 €
WK100	100	297 €	393 €	438 €
WK110	110	315 €	420 €	465 €
WK120	120	334 €	450 €	495 €

ESPECIALES A MEDIDA

CÓDIGO	MEDIDA	TRANSPARENTE	DECORADO	
			GRUPO I	GRUPO II
WKS1070	HASTA 70	317 €	408 €	453 €
WKS1090	HASTA 90	355 €	471 €	516 €
WKS1110	HASTA 110	394 €	535 €	580 €
WKS1140	HASTA 140	432 €	586 €	676 €

INCREMENTO PERFILERÍA COLORES

NEGRO 	+ 20€	ORO MATE 	+ 70€	ORO BRILLO 	+ 70€
BLANCO 	+ 60€	ORO ROSA 	+ 70€		

MAMPARA DE BAÑO SERIE WALK-IN 200

BATHROOM SCREEN WALK-IN 200 SERIES | ÉCRAN DE SALLE DE BAIN SÉRIE WALK-IN 200



MAMPARA ESTANDAR

CÓDIGO	MEDIDA	TRANSPARENTE	DECORADO		TOTAL MEDIDA
			GRUPO I	GRUPO II	
WK070+WK220	70+20	387 €	497 €	542 €	91,1
WK080+WK220	80+20	406 €	525 €	570 €	101,1
WK090+WK220	90+20	424 €	552 €	597 €	111,1
WK100+WK220	100+20	438 €	576 €	621 €	121,1
WK110+WK220	110+20	454 €	602 €	647 €	131,1
WK120+WK220	120+20	474 €	631 €	676 €	141,1
WK070+WK240	70+40	405 €	516 €	561 €	111,1
WK080+WK240	80+40	424 €	543 €	588 €	121,1
WK090+WK240	90+40	441 €	570 €	615 €	131,1
WK100+WK240	100+40	454 €	593 €	638 €	141,1
WK110+WK240	110+40	472 €	620 €	710 €	151,1
WK120+WK240	120+40	492 €	649 €	739 €	161,1
WK220	20	140 €	181 €	226 €	
WK240	40	157 €	199 €	244 €	

ESPECIALES A MEDIDA

CÓDIGO	MEDIDA	TRANSPARENTE	DECORADO	
			GRUPO I	GRUPO II
WKS2030	HASTA 30	182 €	236 €	281 €
WKS2050	HASTA 50	205 €	259 €	304 €

MAMPARA DE BAÑO SERIE FREE 200B

BATHROOM SCREEN FREE 200B SERIES | ÉCRAN DE SALLE DE BAIN SÉRIE FREE 200B



MAMPARA ESTANDAR

CÓDIGO	MEDIDA	TRANSPARENTE	DECORADO	
			GRUPO I	GRUPO II
FR2100B	HASTA 100	496 €	577 €	622 €
FR2120B	HASTA 120	551 €	551 €	596 €
FR2140B	HASTA 140	591 €	591 €	636 €
FR2160B	HASTA 160	608 €	627 €	717 €

**MAMPARA DE BAÑO SERIE VOS 200**

BATHROOM SCREEN VOS 200 SERIES | ÉCRAN DE SALLE DE BAIN SÉRIE VOS 200



MAMPARA ESTANDAR

CÓDIGO	MEDIDA	TRANSPARENTE	DECORADO	
			GRUPO I	GRUPO II
VOS1060	60+40	339 €	429 €	474 €
VOS1070	70+40	353 €	444 €	489 €
VOS1080	80+40	366 €	474 €	519 €
VOS1090	90+40	386 €	512 €	557 €
VOS1100	100+40	399 €	525 €	570 €

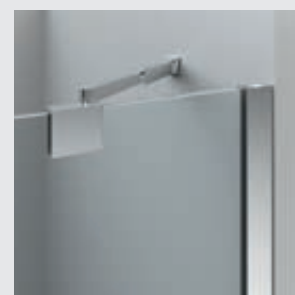

MAMPARA DE BAÑO SERIE XAHA

BATHROOM SCREEN XAHA SERIES | ÉCRAN DE SALLE DE BAIN SÉRIE XAHA



DETALLE PERFIL CLIPADO

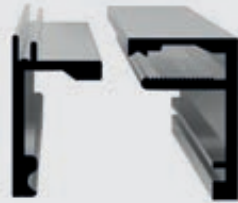





DETALLE PERFIL CLIPADO ABIERTO

ESPECIALES A MEDIDA

CÓDIGO	MEDIDA	TRANSPARENTE	DECORADO	
			GRUPO I	GRUPO II
XA070	HASTA 70	399 €	525 €	585 €
XA090	HASTA 90	451 €	613 €	673 €
XA110	HASTA 110	497 €	695 €	815 €
XA120	HASTA 120	572 €	822 €	942 €

INCREMENTO PERFILERÍA COLORES

NEGRO 	+ 45€	ORO MATE 	+ 50€	ORO BRILLO 	+ 60€
		ORO ROSA 	+ 70€	AZUL 	+ 60€

MAMPARA DE BAÑO SERIE WALK-IN ACANALADO

BATHROOM SCREEN WALK-IN A SERIES | ÉCRAN DE SALLE DE BAIN SÉRIE WALK-IN A



MAMPARA ESTANDAR

CÓDIGO	MEDIDA	ACANALADO
WK-A-70	HASTA 70	465 €
WK-A-80	HASTA 80	495 €
WK-A-90	HASTA 90	530 €
WK-A-100	HASTA 100	568 €
WK-A-110	HASTA 110	610 €
WK-A-120	HASTA 120	650 €
WK-A-130	HASTA 130	690 €
WK-A-140	HASTA 140	745 €

ESPECIALES A MEDIDA

CÓDIGO	MEDIDA	ACANALADO
WKS-A-90	HASTA 90	650 €
WKS-A-110	HASTA 110	745 €
WKS-A-140	HASTA 140	895 €

INCREMENTO PERFILERÍA COLORES

NEGRO 	+ 20€
---	-------

DIMENSIONES MÁXIMAS MAMPARAS A MEDIDA

- Altura máxima 2400 mm
- Ancho máximo 1400 mm

MEDIDAS SUPERIOR CONSULTAR

MAMPARA DE BAÑO SERIE WALK-IN ENMARCADO

BATHROOM SCREEN WALK-IN ENMARCADO SERIES | ÉCRAN DE SALLE DE BAIN SÉRIE WALK-IN ENCADRÉE



MAMPARA ESTANDAR

CÓDIGO	MEDIDA	TRANSPARENTE
ENMARCADO-70	70	361 €
ENMARCADO-80	80	388 €
ENMARCADO-90	90	415 €
ENMARCADO-100	100	438 €
ENMARCADO-110	110	465 €
ENMARCADO-120	120	495 €

INCREMENTO PERFILERÍA COLORES

NEGRO  + 20€**MAMPARA DE BAÑO SERIE WALK-IN DICROICO**

BATHROOM SCREEN WALK-IN DI SERIES | ÉCRAN DE SALLE DE BAIN SÉRIE WALK-IN DI



MAMPARA ESTANDAR

CÓDIGO	MEDIDA	DICROICO
WK-D-70	70	695 €
WK-D-80	80	778 €
WK-D-90	90	861 €
WK-D-100	100	945 €
WK-D-110	110	1.028 €
WK-D-120	120	1.111 €
WK-D-130	130	1.194 €
WK-D-140	140	1.270 €

ESPECIALES A MEDIDA

CÓDIGO	MEDIDA	ACANALADO
WKS-D-90	HASTA 90	995 €
WKS-D-110	HASTA 110	1.211 €
WKS-D-140	HASTA 140	1.531 €

ESPECIFICACIONES TRAMITACIÓN PEDIDOS

- Indicar medida de hueco real para adaptar la mejor opción y evitar errores de códigos
- Indicar posición de puerta mirando la mampara desde fuera (mano)
- Especificar cuando el plato este enrasado a suelo o sea de obra.
- El precio de tratamiento anticorrosión por cada hoja será de 10 €

PLAZO DE EXPEDICIONES

- Transparentes 48 horas
- Decorados 5 días hábiles
- Cristales especiales, decorados, acanalados y cristal dicróico 15 días.

Bañera





MAMPARA DE BAÑO SERIE PAB100

BATHROOM SCREEN PAB 100 SERIES | ÉCRAN DE SALLE DE BAIN SÉRIE PAB 100



MAMPARA ESTANDAR

CÓDIGO	MEDIDA	TRANSPARENTE	DECORADO	
			GRUPO I	GRUPO II
PAB100 VELA	85	173 €	245 €	290 €

MAMPARA DE BAÑO SERIE PAB200

BATHROOM SCREEN PAB 200 SERIES | ÉCRAN DE SALLE DE BAIN SÉRIE PAB 200



MAMPARA ESTANDAR

CÓDIGO	MEDIDA	TRANSPARENTE	DECORADO	
			GRUPO I	GRUPO II
PAB200	40+70	322 €	409 €	454 €

ESPECIALES A MEDIDA

CÓDIGO	MEDIDA	TRANSPARENTE	DECORADO	
			GRUPO I	GRUPO II
PAB200 ESPECIAL	ESPECIAL	391 €	465 €	510 €

MAMPARA DE BAÑO SERIE ATEMPO 500

BATHROOM SCREEN ATEMPO 500 SERIES | ÉCRAN DE SALLE DE BAIN SÉRIE ATEMPO 500



MAMPARA ESTANDAR

CÓDIGO	MEDIDA	RANGO DE INSTALACIÓN	TRANSPARENTE	DECORADO		APERTURA
				GRUPO I	GRUPO II	
AT5160	160	152 - 162	667 €	793 €	838 €	58 - 67
AT5170	170	162 - 172	679 €	812 €	857 €	58 - 67

ESPECIALES A MEDIDA

CÓDIGO	MEDIDA	TRANSPARENTE	DECORADO	
			GRUPO I	GRUPO II
ATS5140	HASTA 140	867 €	928 €	973 €
ATS5160	HASTA 160	913 €	980 €	1.070 €
ATS5180	HASTA 180	958 €	1.033 €	1.123 €
ATS5200	HASTA 200	1.003 €	1.085 €	1.175 €
ATS5220	HASTA 220	1.049 €	1.138 €	1.228 €

MAMPARA DE BAÑO SERIE URBAN 500

BATHROOM SCREEN URBAN 500 SERIES | ÉCRAN DE SALLE DE BAIN SÉRIE URBAN 500



MAMPARA ESTANDAR

CÓDIGO	MEDIDA	RANGO DE INSTALACIÓN	TRANSPARENTE	DECORADO		APERTURA
				GRUPO I	GRUPO II	
UR5140	140	135 - 140	378 €	462 €	507 €	57
UR5150	150	145 - 150	390 €	512 €	602 €	62
UR5160	160	155 - 160	402 €	532 €	622 €	67
UR5170	170	165 - 170	414 €	552 €	642 €	72

ESPECIALES A MEDIDA

CÓDIGO	MEDIDA	TRANSPARENTE	DECORADO	
			GRUPO I	GRUPO II
UR55140	HASTA 140	524 €	701 €	746 €
UR55160	HASTA 160	545 €	747 €	837 €
UR55180	HASTA 180	567 €	793 €	883 €
UR55200	HASTA 200	589 €	839 €	929 €
UR55220	HASTA 220	611 €	886 €	976 €

MAMPARA DE BAÑO SERIE PAD500

BATHROOM SCREEN PAD 500 SERIES | ÉCRAN DE SALLE DE BAIN SÉRIE PAD 500



MAMPARA ESTANDAR

CÓDIGO	MEDIDA	TRANSPARENTE	DECORADO	
			GRUPO I	GRUPO II
PADEL500	40 + 80	270 €	349 €	394 €

ESPECIALES A MEDIDA

CÓDIGO	MEDIDA	TRANSPARENTE	DECORADO	
			GRUPO I	GRUPO II
PADEL500ESP	ESPECIAL	350 €	440 €	485 €

MAMPARA DE BAÑO SERIE FREE 500

BATHROOM SCREEN FREE 500 SERIES | ÉCRAN DE SALLE DE BAIN SÉRIE FREE 500



MAMPARA ESTANDAR

CÓDIGO	MEDIDA	TRANSPARENTE	DECORADO	
			GRUPO I	GRUPO II
FR5100	HASTA 100	471 €	543 €	588 €
FR5120	HASTA 120	525 €	634 €	679 €
FR5140	HASTA 140	549 €	711 €	756 €

ESPECIALES A MEDIDA

CÓDIGO	MEDIDA	TRANSPARENTE	DECORADO	
			GRUPO I	GRUPO II
FRS5140	HASTA 140	714 €	1.038 €	1.083 €
FRS5160	HASTA 160	734 €	1.067 €	1.157 €
FRS5180	HASTA 180	754 €	1.102 €	1.192 €
FRS5200	HASTA 200	774 €	1.240 €	1.330 €
FRS5215	HASTA 215	515 €	639 €	639 €

MAMPARA DE BAÑO SERIE WALK-IN 500

BATHROOM SCREEN WALK-IN 500 SERIES | ÉCRAN DE SALLE DE BAIN SÉRIE WALK-IN 500



MAMPARA ESTANDAR

CÓDIGO	MEDIDA	TRANSPARENTE	DECORADO	
			GRUPO I	GRUPO II
WK508	80	180 €	247 €	292 €
WK509	90	204 €	251 €	296 €

ESPECIALES A MEDIDA

CÓDIGO	MEDIDA	TRANSPARENTE	DECORADO	
			GRUPO I	GRUPO II
WKS508	HASTA 80	236 €	320 €	365 €
WKS509	HASTA 90	267 €	326 €	371 €

INCREMENTO PERFILERÍA COLORES

- NEGRO + 20€
 ORO MATE + 70€
 ORO BRILLO + 70€
 BLANCO + 60€
 ORO ROSA + 70€

MAMPARA DE BAÑO SERIE PAB100 RECTA

BATHROOM SCREEN PAB 100 SERIES | ÉCRAN DE SALLE DE BAIN SÉRIE PAB 100



MAMPARA ESTANDAR

CÓDIGO	MEDIDA	TRANSPARENTE	DECORADO	
			GRUPO I	GRUPO II
PAB100 RECTA	85	173 €	245 €	290 €

ESPECIALES A MEDIDA

CÓDIGO	MEDIDA	TRANSPARENTE	DECORADO	
			GRUPO I	GRUPO II
PAB100RECTAESP	ESPECIAL	238 €	281 €	326 €

Duchas







KUBIC

Grifería termostática.

Sistema termostático que regula el caudal y al mismo tiempo mantiene la temperatura del agua a tu gusto.

Sistema anti quemaduras.

Mantiene el cuerpo de metal a una temperatura moderada, aunque el agua este muy caliente, evitando de este modo, posibles quemaduras.

Rociador acero inoxidable.

Sistema de lluvia extra plano de 25 x 25 con sistema de anti-cal.

Altura regulable

99.5/135.5 cm.

Cartucho termostático.

Realizado en acero inoxidable, de fácil acceso para su mantenimiento.

Precio: 429€



SPIRIT

Grifería termostática

Sistema termostático que regula el caudal y al mismo tiempo mantiene la temperatura del agua a tu gusto.

Sistema anti quemaduras.

Mantiene el cuerpo de metal a una temperatura moderada, aunque el agua este muy caliente, evitando de este modo, posibles quemaduras.

Rociador acero inoxidable.

Sistema de lluvia extra plano de 25cm de diámetro con sistema de anti-cal.

Altura regulable

91.7/136.7 cm.

Cartucho termostático.

Realizado en acero inoxidable, de fácil acceso para su mantenimiento.

Precio: 358€



TERMO BLACK

Grifería termostática

Sistema termostático que regula el caudal y al mismo tiempo mantiene la temperatura del agua a tu gusto.

Sistema anti quemaduras.

Mantiene el cuerpo de metal a una temperatura moderada, aunque el agua este muy caliente, evitando de este modo, posibles quemaduras.

Rociador ABS.

Altura regulable

Precio: 358€



FORMA

Grifería monomando.

Rociador ABS CROMADO.

Sistema de lluvia plano de 20 X 20 cm
con sistema de anti-cal.

Altura regulable

107 / 147 cm.

Precio: 274 €



DIRECT

Grifería monomando.

Rociador ABS CROMADO.

Sistema de lluvia plano
de 20 cm de diámetro con
sistema de anti-cal.

Altura regulable
91.6 / 126.6 cm.

Precio: 380 €



ESENCIA

Diseño de columna ESENCIA acabado en aluminio y jets de hidromasaje

Grifería monomando o termostática.

Cascada.

Rociador superior con jets efecto lluvia 15x10 cm.

2 jets de hidromasaje fijos.

Medidas:

Ancho 20 cm.

Alto 145 cm.

Salida máxima de la ducha 44 cm.

Precio monomando: 273 €

Precio termostática: 310 €



ENERGI

Diseño de columna ENERGI acabado en acero inoxidable y jets de hidromasaje.

Grifería monomando o termostática.

Cascada.

Rociador superior con jets efecto lluvia 15x10 cm.

2 jets de hidromasaje fijos.

Medidas:

Ancho 20 cm.

Alto 148 cm.

Salida máxima de la ducha 57 cm.

Precio monomando: 294 €

Precio termostática: 326 €

RIVER

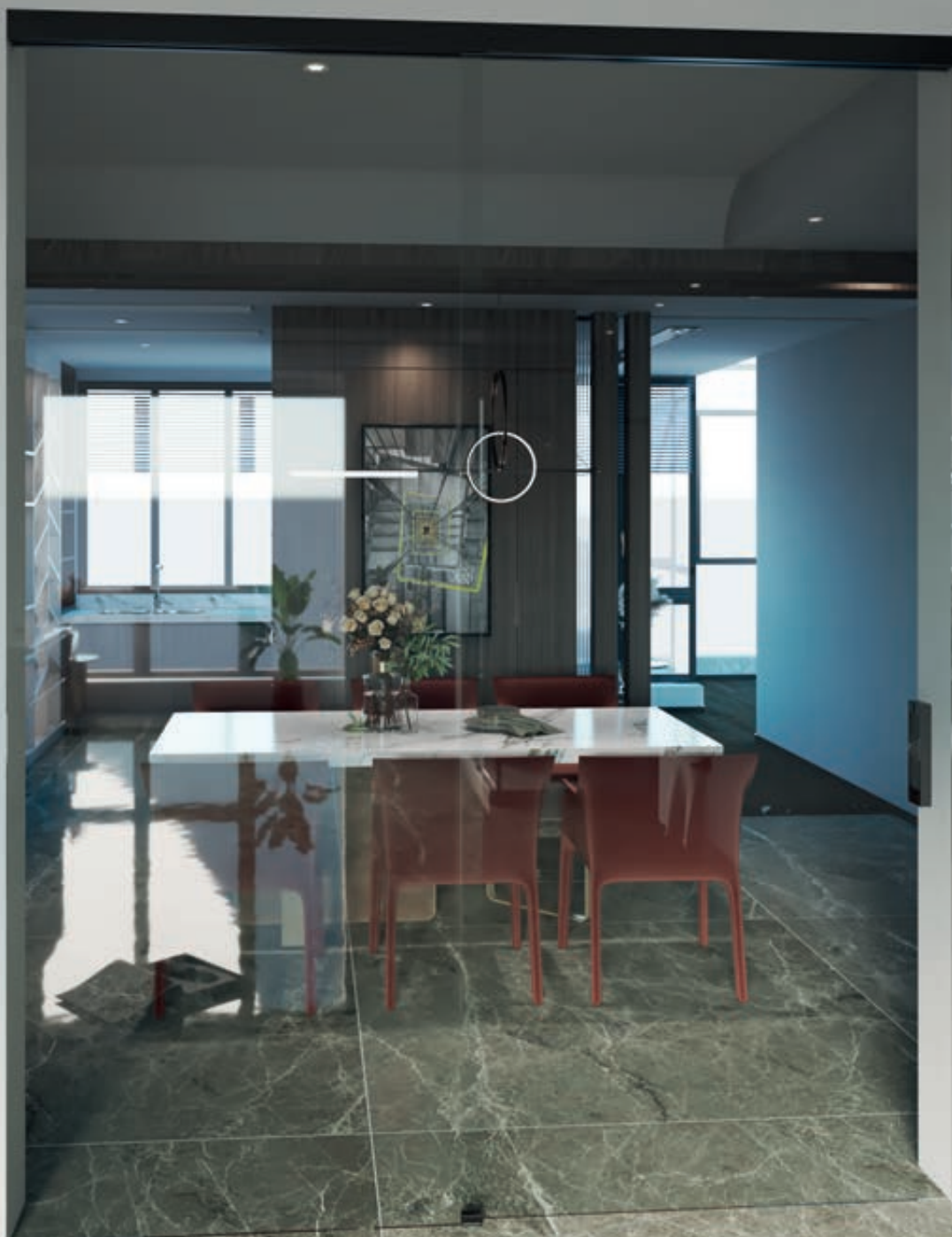

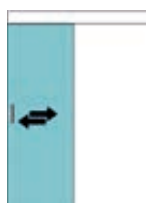
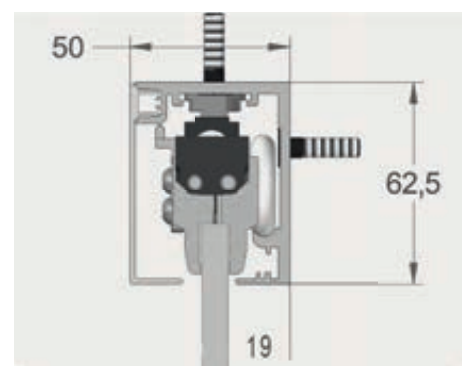

CÓDIGO	MEDIDA	TRANSPARENTE	DECORADO	
			GRUPO I	GRUPO II
RV01060	HASTA 60	920 €	998 €	1.076 €
RV01080	HASTA 80	967 €	1.071 €	1.175 €
RV01090	HASTA 90	990 €	1.107 €	1.224 €

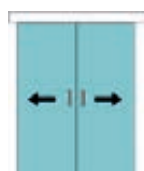

CÓDIGO	MEDIDA	TRANSPARENTE	DECORADO	
			GRUPO I	GRUPO II
RV02080	HASTA 80	1.253 €	1.357 €	1.461 €
RV02100	HASTA 100	1.300 €	1.430 €	1.560 €
RV02120	HASTA 120	1.346 €	1.502 €	1.658 €
RV02140	HASTA 140	1.393 €	1.575 €	1.757 €
RV02160	HASTA 160	1.440 €	1.648 €	1.856 €



CÓDIGO	MEDIDA	TRANSPARENTE	DECORADO	
			GRUPO I	GRUPO II
RV03120	HASTA 120	1.060 €	1.216 €	1.372 €
RV03140	HASTA 140	1.107 €	1.289 €	1.471 €
RV03160	HASTA 160	1.154 €	1.362 €	1.570 €
RV03180	HASTA 180	1.201 €	1.435 €	1.669 €
RV03200	HASTA 200	1.248 €	1.508 €	1.768 €
RV03220	HASTA 220	1.499 €	1.785 €	2.071 €
RV03240	HASTA 240	1.546 €	1.858 €	2.170 €



CÓDIGO	MEDIDA	TRANSPARENTE	DECORADO	
			GRUPO I	GRUPO II
RV04140	HASTA 140	1.394 €	1.575 €	1.757 €
RV04160	HASTA 160	1.440 €	1.648 €	1.856 €
RV04180	HASTA 180	1.487 €	1.721 €	1.955 €
RV04200	HASTA 200	1.739 €	1.998 €	2.258 €
RV04220	HASTA 220	1.786 €	2.071 €	2.357 €
RV04240	HASTA 240	1.832 €	2.144 €	2.456 €

• EXTRA PERFILERÍA COLOR NEGRO +65 €.
PLAZO DE EXPEDICIÓN 15 DÍAS

HIDE



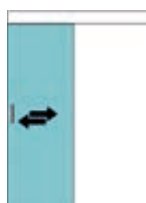
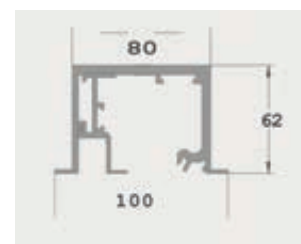

CÓDIGO	MEDIDA	TRANSPARENTE	DECORADO	
			GRUPO I	GRUPO II
HD01060	HASTA 60	1.073 €	1.151 €	1.229 €
HD01080	HASTA 80	1.119 €	1.223 €	1.327 €
HD01090	HASTA 90	1.143 €	1.260 €	1.377 €

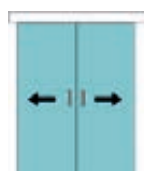

CÓDIGO	MEDIDA	TRANSPARENTE	DECORADO	
			GRUPO I	GRUPO II
HD02080	HASTA 80	1.490 €	1.594 €	1.698 €
HD02100	HASTA 100	1.537 €	1.641 €	1.745 €
HD02120	HASTA 120	1.584 €	1.714 €	1.844 €
HD02140	HASTA 140	1.630 €	1.786 €	1.942 €
HD02160	HASTA 160	1.677 €	1.859 €	2.041 €



CÓDIGO	MEDIDA	TRANSPARENTE	DECORADO	
			GRUPO I	GRUPO II
HD03120	HASTA 120	1.213 €	1.369 €	1.525 €
HD03140	HASTA 140	1.260 €	1.442 €	1.624 €
HD03160	HASTA 160	1.307 €	1.515 €	1.723 €
HD03180	HASTA 180	1.353 €	1.587 €	1.821 €
HD03200	HASTA 200	1.631 €	1.891 €	2.151 €
HD03220	HASTA 220	1.678 €	1.964 €	2.250 €
HD03240	HASTA 240	1.725 €	2.037 €	2.349 €

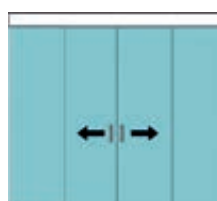

CÓDIGO	MEDIDA	TRANSPARENTE	DECORADO	
			GRUPO I	GRUPO II
HD04140	HASTA 140	1.630 €	1.812 €	1.994 €
HD04160	HASTA 160	1.677 €	1.885 €	2.094 €
HD04180	HASTA 180	1.727 €	1.961 €	2.195 €
HD04200	HASTA 200	2.011 €	2.241 €	2.531 €
HD04220	HASTA 220	2.065 €	2.351 €	2.637 €
HD04240	HASTA 240	2.118 €	2.430 €	2.742 €

PLAZO DE EXPEDICIÓN 15 DÍAS

OCEAN



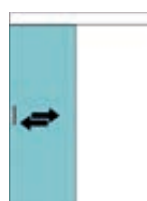
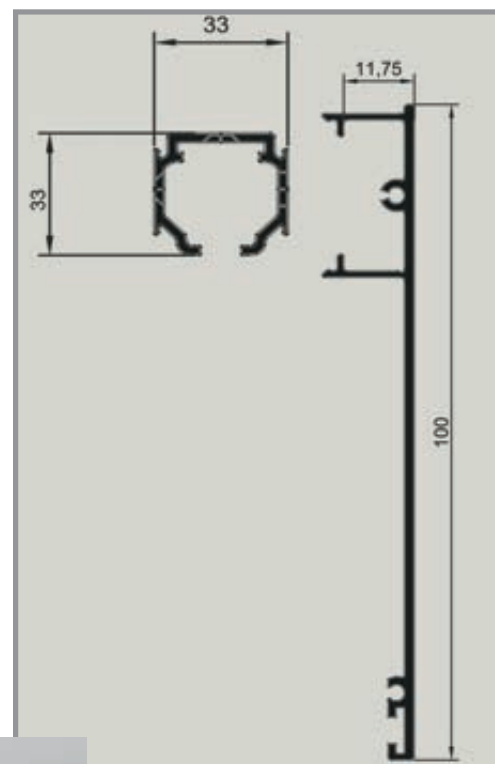

CÓDIGO	MEDIDA	TRANSPARENTE	DECORADO	
			GRUPO I	GRUPO II
OC01060	HASTA 60	585 €	663 €	741 €
OC01080	HASTA 80	632 €	736 €	840 €
OC01090	HASTA 90	655 €	772 €	889 €

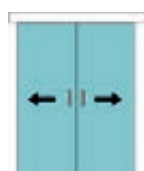

CÓDIGO	MEDIDA	TRANSPARENTE	DECORADO	
			GRUPO I	GRUPO II
OC02080	HASTA 80	792 €	896 €	1.000 €
OC02100	HASTA 100	838 €	968 €	1.098 €
OC02120	HASTA 120	885 €	1.041 €	1.197 €
OC02140	HASTA 140	987 €	1.169 €	1.351 €
OC02160	HASTA 160	1.034 €	1.242 €	1.450 €



CÓDIGO	MEDIDA	TRANSPARENTE	DECORADO	
			GRUPO I	GRUPO II
OC03120	HASTA 120	995 €	1.151 €	1.307 €
OC03140	HASTA 140	1.042 €	1.224 €	1.406 €
OC03160	HASTA 160	1.089 €	1.297 €	1.505 €
OC03180	HASTA 180	1.136 €	1.370 €	1.604 €
OC03200	HASTA 200	1.183 €	1.443 €	1.703 €
OC03220	HASTA 220	1.489 €	1.775 €	2.061 €
OC03240	HASTA 240	1.536 €	1.848 €	2.160 €



CÓDIGO	MEDIDA	TRANSPARENTE	DECORADO	
			GRUPO I	GRUPO II
OC04140	HASTA 140	1.185 €	1.367 €	1.549 €
OC04160	HASTA 160	1.232 €	1.440 €	1.648 €
OC04180	HASTA 180	1.279 €	1.513 €	1.747 €
OC04200	HASTA 200	1.326 €	1.586 €	1.846 €
OC04220	HASTA 220	1.632 €	1.918 €	2.204 €
OC04240	HASTA 240	1.679 €	1.991 €	2.303 €

• EXTRA PERFILERÍA COLOR NEGRO +65 €.
PLAZO DE EXPEDICIÓN 15 DÍAS

DECORADOS



Franja

Decorado **GRUPO I**



Loft

Decorado **GRUPO I**



Mate

Decorado **GRUPO I**



Rayas

Decorado **GRUPO I**

DECORADOS



Enmarcado Digital

Decorado **GRUPO II**

Vintage

*Decorado Vintage SÓLO disponible en Walk-In*Decorado **GRUPO II**

Industrial

Decorado **GRUPO II**Colors Decorado **GRUPO II**

DECORADOS



Nipon

Decorado **GRUPO II**



Parsol Bronze

Decorado **GRUPO I**



Parsol Fume

Decorado **GRUPO I**



Parsol Mirastar
Decorado Mirastar incremento 179€/m²

Decorado **GRUPO I**
+ Incremento

DECORADOS



Taiga

Decorado **GRUPO II**

Tex

Decorado **GRUPO II**

Ultra Fino

Decorado **GRUPO II**

Ladrillo

Decorado **GRUPO II**

ACABADOS



Blanco



Negro



Platabrillo



Azul

ACABADOS



Oro Mate



Oro Brillo



Oro Rosa

REPUESTOS

	TIRADOR		RODAMIENTO		PERFIL SUPERIOR		PERFIL FIJO		PERFIL MAGNETICO		JUNQUILLO INFERIOR		GOMAS VERTICALES	
MAGNA	MGT01	44 €	MGR02	33 €	MGPS03	154 €	MGPF04	83 €	MGPM05	88 €	MGJI06	24 €	MGGV07	17 €
ATEMPO	AT T01	28 €	ATR02	44 €	ATPS03	139 €	ATPF04	33 €	ATPM05	31 €	ATJI06	24 €	ATGV07	17 €
LUXURY	LXT01	44 €	LXR02	33 €	LXPS03	154 €	LXPF04	72 €	LXPM05	39 €	LXJI06	24 €	LXGV07	17 €
FREE	FRT01	55 €	FRR02	33 €	-	-	FRPF04	33 €	FRPM05	39 €	FRJI06	24 €	FRGV07	17 €
ELEGANT	ELT01	44 €	ELR02	33 €	ELPS03	154 €	ELPF04	72 €	ELPM05	39 €	ELJI06	24 €	ELGV07	17 €
URBAN	URT01	33 €	URR02	23 €	URPS03	61 €	URPF04	46 €	URPM05	52 €	URJI06	24 €	URGV07	17 €
SLIM	SLT01	55	SLR02	23 €	SLPS03	61 €	SLPF04	46 €	SLPM05	52 €	SLJI06	24 €	SLGV07	17 €
COSMOS	CST01	33 €	CSR02	23 €	CSPS03	61 €	CSPF04	31 €	CSPM05	52 €	CSJI06	24 €	CSGV07	17 €
ECO	ECT01	26 €	ECR02	22 €	ECPS03	47 €	ECPF04	40 €	ECPM05	40 €	ECJI06	24 €	ECGV07	17 €
TOP	TPT01	55 €	TPR02	23 €	TPPS03	47 €	TPPF04	40 €	TPPM05	40 €	TPJI06	24 €	TPGV07	17 €
TREBOL	TRT01	33 €	TRR02	33 €	TRPS03	61 €	TRPF04	31 €	TRPM05	40 €	TRJI06	24 €	TRGV07	17 €
TEDY	TDT01	44 €	-	-	-	-	TDPF04	46 €	TDPM05	31 €	TDJI06	24 €	TDGV07	17 €
PADEL	PDT01	44 €	-	-	-	-	PDPF04	46 €	PDPM05	31 €	PDJI06	24 €	-	-
ACORD	ACT01	-	-	-	-	-	ACPF04	-	ACPM05	31 €	ACJI06	24 €	-	-
MIXTA	MXT01	44 €	MXR02	33 €	MXPS03	61 €	MXPF04	46 €	-	-	MXJI06	24 €	MXGV07	17 €
WALK-IN	-	-	-	-	-	-	WKPF04	33 €	-	-	WKJI06	24 €	-	-
VOS	VST01	33 €	-	-	-	-	VSPF04	33 €	-	-	VSJI06	24 €	-	-
PAB100	-	-	-	-	-	-	PBPF04	-	-	-	-	-	-	-
PAB200	PBT01	25 €	-	-	-	-	-	-	-	-	-	-	PBGV07	17 €

CRISTALES	HASTA 45MM			HASTA 65MM			HASTA 85MM			HASTA 105MM		
	TRANSP.	DECORADO G1	DECORADO G2	TRANSP.	DECORADO G1	DECORADO G2	TRANSP.	DECORADO G1	DECORADO G2	TRANSP.	DECORADO G1	DECORADO G2
8MM PUERTA	160 €	195 €	230 €	203 €	252 €	301 €	260 €	320 €	380 €	-	-	-
8MM FIJO	140 €	175 €	210 €	185 €	234 €	283 €	240 €	300 €	360 €	314 €	392 €	470 €
6MM PUERTA	105 €	140 €	175 €	132 €	181 €	230 €	150 €	210 €	270 €	-	-	-
6MM FIJO	71 €	106 €	141 €	91 €	140 €	189 €	91 €	151 €	211 €	154 €	232 €	310 €

	GOMAS MAGNETICAS		VIERTE AGUAS		BISAGRAS PARED		BISAGRAS ENTRE CRISTALES		PERFIL GIRO		SOPORTE PERFIL		TENSOR SEGURIDAD	
MAGNA	MGGM08	25 €	MGVI09	11 €	-	-	-	-	-	-	-	-	-	-
ATEMPO	ATGM08	25 €	ATVI09	11 €	-	-	-	-	-	-	-	-	-	-
LUXURY	LXGM08	25 €	LXVI09	11 €	-	-	-	-	-	-	-	-	-	-
FREE	FRGM08	25 €	FRVI09	11 €	-	-	-	-	-	-	-	-	-	-
ELEGANT	ELGM08	25 €	ELVI09	11 €	-	-	-	-	-	-	-	-	-	-
URBAN	URGM08	25 €	URVI09	11 €	-	-	-	-	-	-	-	-	-	-
SLIM	SLGM08	25 €	SLVI09	11 €	-	-	-	-	-	-	-	-	-	-
COSMOS	CSGM08	25 €	CSVI09	11 €	-	-	-	-	-	-	-	-	-	-
ECO	ECGM08	25 €	ECVI09	11 €	-	-	-	-	-	-	-	-	-	-
TOP	TPGM08	25 €	TPVI09	11 €	-	-	-	-	-	-	-	-	-	-
TREBOL	TRGM08	25 €	TRVI09	11 €	-	-	-	-	-	-	-	-	-	-
TEDY	TDGM08	25 €	TDVI09	11 €	TDBP10	50 €	TDBC11	55 €	-	-	-	-	TDTS14	61 €
PADEL	PDGM08	25 €	PDVI09	11 €	-	-	-	-	PDPG12	61 €	PDSP13	17 €	PDTS14	61 €
ACORD	ACGM08	25 €	ACVI09	11 €	-	-	ACBC11	53 €	ACPG12	61 €	ACSP13	17 €	ACTS14	61 €
MIXTA	MXGM08	25 €	MXVI09	11 €	-	-	MXBC11	53 €	-	-	-	-	-	-
WALK-IN	-	-	WKVI09	11 €	-	-	-	-	WKPG12	61 €	WKSP13	17 €	WKTS14	61 €
VOS	-	-	VSVI09	11 €	-	-	-	-	VSPG12	61 €	VSSP13	17 €	VSTS14	61 €
PAB100	-	-	PBVI09	11 €	-	-	-	-	PBPG12	61 €	PBSP13	17 €	-	-
PAB200	-	-	PBVI09	11 €	-	-	PBBC11	53 €	-	-	-	-	PBTS14	61 €

COMPLEMENTOS DE COLOCACIÓN

































IMAGEN	CÓDIGO	NOMBRE	PRECIO
 10x20	TB1020BR	TUBO ALUMINIO 10X20 MM PLATA	30 €
 20x20	TB2020BR	TUBO ALUMINIO 20X20 MM PLATA	33 €
 40x20	TB4020BR	TUBO ALUMINIO 40X20 MM PLATA	39 €
 40x40	TB4040BR	TUBO ALUMINIO 40X40 MM PLATA	44 €
 60x20	TB6020BR	TUBO ALUMINIO 60X20 MM PLATA	55 €
 60x40	TB6040BR	TUBO ALUMINIO 60X40 MM PLATA	61 €
 80x40	TB8040BR	TUBO ALUMINIO 80X40 MM PLATA	66 €
 20	PL20BR	PLETINA DE ALUMINIO 20 MM PLATA	22 €
 25	PL25BR	PLETINA DE ALUMINIO 25 MM PLATA	28 €
 30	PL30BR	PLETINA DE ALUMINIO 30 MM PLATA	33 €
 40	PL40BR	PLETINA DE ALUMINIO 40 MM PLATA	39 €
 20x20	AG2020BR	ANGULO DE ALUMINIO 20X20 MM PLATA	33 €
 40x40	AG2040BR	ANGULO DE ALUMINIO 40X40 MM PLATA	55 €
 10x20	TB1020N	TUBO ALUMINIO 10X20 MM NEGRO	33 €
 20x20	TB2020N	TUBO ALUMINIO 20X20 MM NEGRO	36 €
 40x20	TB4020N	TUBO ALUMINIO 40X20 MM NEGRO	43 €
 40x40	TB4040N	TUBO ALUMINIO 40X40 MM NEGRO	48 €
 25	PL25N	PLETINA DE ALUMINIO 25 MM NEGRO	31 €

IMAGEN	CÓDIGO	NOMBRE	PRECIO
 10x20	TB1020OM	TUBO ALUMINIO 10X20 MM ORO MATE	39 €
 20x20	TB2020OM	TUBO ALUMINIO 20X20 MM ORO MATE	43 €
 40x20	TB4020OM	TUBO ALUMINIO 40X20 MM ORO MATE	51 €
 40x40	TB4040OM	TUBO ALUMINIO 40X40 MM ORO MATE	57 €
 25	PL25OM	PLETINA DE ALUMINIO 25 MM ORO MATE	36 €
 10x20	TB1020OR	TUBO ALUMINIO 10X20 MM ORO ROSA	39 €
 20x20	TB2020OR	TUBO ALUMINIO 20X20 MM ORO ROSA	43 €
 40x20	TB4020OR	TUBO ALUMINIO 40X20 MM ORO ROSA	51 €
 40x40	TB4040OR	TUBO ALUMINIO 40X40 MM ORO ROSA	57 €
 25	PL25OR	PLETINA DE ALUMINIO 25 MM ORO ROSA	36 €
 10x20	TB1020OB	TUBO ALUMINIO 10X20 MM ORO BRILLO	39 €
 20x20	TB2020OB	TUBO ALUMINIO 20X20 MM ORO BRILLO	43 €
 40x20	TB4020OB	TUBO ALUMINIO 40X20 MM ORO BRILLO	51 €
 40x40	TB4040OB	TUBO ALUMINIO 40X40 MM ORO BRILLO	57 €
 25	PL25OB	PLETINA DE ALUMINIO 25 MM ORO BRILLO	36 €



Tirador redondo
máxima entrada
45 €

Sólo disponible para mamparas a medida.



Tirador rectangular
máxima entrada
45 €

Sólo disponible para mamparas a medida.



TSCP



TSPV



TSPF

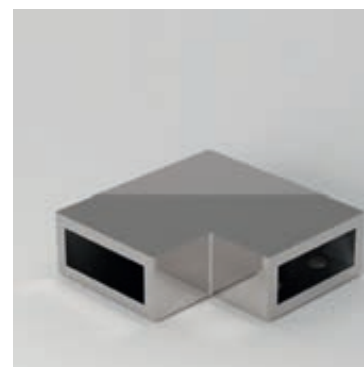

TSAG



TSPPF



TSTP



TSRB



TSPT

CÓDIGO	NOMBRE	PRECIO
TSB2M	BARRA TENSORA PLATA	55 €
TSCP	CONECTOR PARED PLATA	20 €
TSPF	TERMINAL FIJO PLATA	24 €
TSPPF	PINZA PASANTE LATERAL PLATA	22 €
TSPV	PINZA PASANTE VERTICAL PLATA	22 €
TSRB	PINZA PASANTE CENTRAL PLATA	36 €
TSAG	CONECTOR ANGULAR PLATA	24 €
TSTP	CONECTOR PASANTE "T" PLATA	20 €
TSPT	PINZA A TECHO PLATA	24 €

CÓDIGO	NOMBRE	PRECIO
TSB2MOM	BARRA TENSORA ORO MATE	70 €
TSCPOM	CONECTOR PARED ORO MATE	30 €
TSPFOM	TERMINAL FIJO ORO MATE	34 €
TSPPFOM	PINZA PASANTE LATERAL ORO MATE	32 €

CÓDIGO	NOMBRE	PRECIO
TSB2MN	BARRA TENSORA NEGRO	60 €
TSCPEN	CONECTOR PARED NEGRO	25 €
TSPFEN	TERMINAL FIJO NEGRO	29 €
TSPPFEN	PINZA PASANTE LATERAL NEGRO	27 €

CÓDIGO	NOMBRE	PRECIO
TSB2MOB	BARRA TENSORA ORO BRILLO	70 €
TSCP OB	CONECTOR PARED ORO BRILLO	30 €
TSPFOB	TERMINAL FIJO ORO BRILLO	34 €
TSPPF OB	PINZA PASANTE LATERAL ORO BRILLO	32 €

CÓDIGO	NOMBRE	PRECIO
TSB2MOR	BARRA TENSORA ORO ROSA	70 €
TSCPOR	CONECTOR PARED ORO ROSA	30 €
TSPFOR	TERMINAL FIJO ORO ROSA	34 €
TSPPFOR	PINZA PASANTE LATERAL ORO ROSA	32 €

TENSORES OPCIONALES



TSS400



TSS900

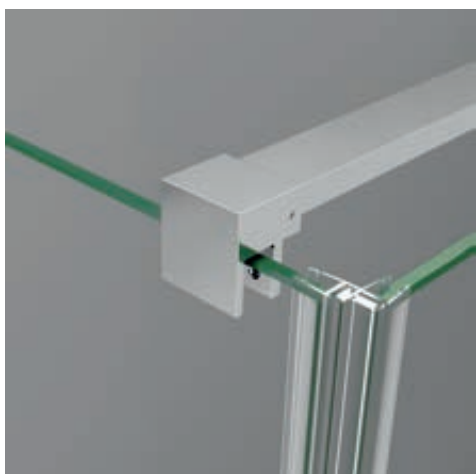

TSS300

CÓDIGO	NOMBRE	ACABADO PLATA	ACABADO NEGRO	ACABADOS OROS
TSS400	TENSOR OPCIONAL PARA FIJO FRONTAL Y LATERAL	121 €	141 €	166 €
TSS900	TENSOR OPCIONAL PARA DOS FIJOS FRONTALES	139 €	164 €	194 €
TSS300	TENSOR OPCIONAL ANGULAR PARA DOS FIJOS	163 €	-	-

ACCESORIOS DE LIMPIEZA Y MANTENIMIENTO

*Porte + 5€ si la venta es individual

Rasquetas limpiacristales 30 €



LIMPIACRISTALES-N



LIMPIACRISTALES-CR



LIMPIACRISTALES-N



LIMPIACRISTALES-CR

Kit tratamiento antical 30 €



KIT ANTICAL CASTEL



CONDICIONES DE VENTA DE DEBANIO

PEDIDOS

La solicitud de un pedido implica la aceptación de nuestras condiciones generales de venta.

Las descripciones y fotografías contenidas en nuestro catálogo deben entenderse a nivel informativo. Debanio se reserva el derecho a modificar parcial o totalmente los productos en cualquier momento y sin previo aviso.

ANULACIONES

Debanio aceptará las anulaciones o modificaciones por parte del cliente en los siguientes casos:

Se anulará el pedido sin cargo para el cliente en el caso de que no haya sido servido. Siempre que sean mamparas standars, en caso de ser a medida, se realizará el cargo de lo que este realizado.

DEVOLUCIONES

Debanio no aceptara devoluciones de ningún tipo.

PRECIOS

Los precios de venta son los indicados en la tarifa vigente en el momento de la recepción del pedido.

Debanio se reserva el derecho de revisar y variar dichos precios sin previo aviso.

Los precios contemplados en esta tarifa están en euros y sin IVA .

Los precios no incluyen montaje.

PLAZOS DE ENTREGA

Los plazos de entrega son de carácter informativo y no supondrán en ningún caso motivo de reclamación de responsabilidades a ningún efecto .

En el caso de que el plazo de entrega sea indispensable para el comprador, deberá especificarse por escrito en el momento de cursar el pedido y deberá ser notificado por Debanio por escrito si el plazo no fuera aceptado.

TRANSPORTE

La mercancía debe ser verificada visualmente a la recepción y hacerse constar cualquier anomalía en el albarán de entrega.

Dicha anomalía debe ser a su vez, notificada a Debanio.

Transcurridas 24 horas de la recepción de la mercancía no se admitirá devolución por rotura o deterioro que no se haya hecho constar en el albarán de entrega.

GARANTÍA

Debanio garantiza sus productos contra todo defecto de fabricación según las normas establecidas a continuación.

El periodo de garantía es de 3 años a partir de la fecha de compra, la garantía es total, subsanándose sin cargo para el usuario cualquier defecto de fabricación.

La garantía no sera operativa en los siguientes casos:

- a) Daños producidos por el incumplimiento de las instrucciones dadas por el fabricante para la instalación.
- b) Corrosión, calcificación o abrasión motivada por falta de limpieza y/o mantenimiento, utilización indebida, almacenamiento o malos tratos, roturas o desperfectos por normal uso o cualquier otra causa ajena al producto.
- c) Utilización de piezas de recambios no originales.

En particular, Debanio declina toda responsabilidad por daños a personas o a cosas que pudieran ser ocasionadas por algunas de las causas especificadas en el apartado anterior.

Cualquier reclamación no especificada en los apartados anteriores, esta excluida a menos que la ley prevea expresamente su responsabilidad.

Para cualquier reclamación con cargo a garantía, deberá dirigirse al establecimiento donde la adquirió y si ello no fuera posible a Debanio.

Nuestra garantía no afecta a los derechos que dispone el consumidor conforme a la ley 23/2002 de 23 de julio, de garantías en la venta de bienes de consumo y demás normativas de aplicación.

JURISDICCIÓN

En caso de litigio serán únicamente competentes los tribunales de la ciudad de Castellón.

IMPUESTOS

Serán cargados en la factura según la legislación vigente.

RESERVA DE DOMINIO

Nuestras ventas se consideran siempre bajo la condición de reserva de dominio y según el artículo 1506 del Código Civil hasta que no se haya hecho efectivo el pago íntegro de la mercancía en depósito.



Grosor del cristal de seguridad
Thick safety glass



Aluminio
Aluminium



Acero inoxidable
Stainless steel

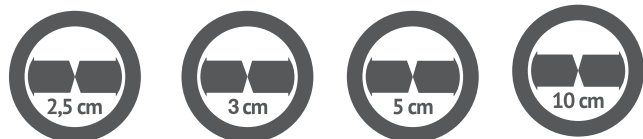

Compensación en cruce de cristales
Junction compensation in glasses

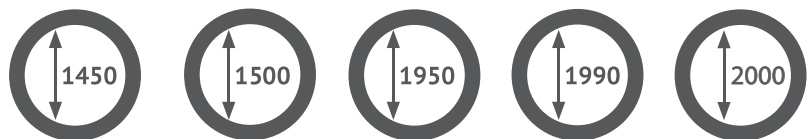

Altura
Hig



Antical
Anti-lime

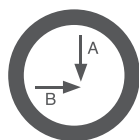

Suma de lados
Sum of sides



Reversible
Reversible

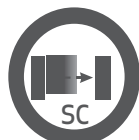

Cierre progresivo
Soft Close



Fácil montaje
Easy Assembly



Camí de Miralcamp, 109
Apdo. Correos 229
12200 ONDA - Castellón - España

T. +34 964 522 002
info@debanio.com

www.castel.com.es